



# decomagazine

THINK PARTS THINK TORNOS

61 02/12 ENGLISH



**The hidden**  
"secrets" of  
MultiSwiss



**Responsible**  
production...

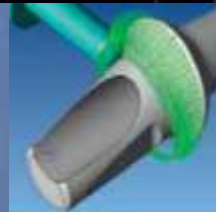

**Mastercam**  
Swiss Expert: 2012  
version and satisfied  
customers



**Uncommon**  
expertise

**WERKZEUGE FÜR DIE MEDIZINALTECHNIK**

GEWINDEWIRBELN

**OUTILLAGE POUR L'INDUSTRIE MÉDICALE**

TOURBILLONNAGE

**TOOLS FOR THE MEDICAL INDUSTRY**

THREAD WHIRLING



ENVIRONNEMENT  
PROFESSIONNEL  
HORLOGERIE  
JOAILLERIE

SALON INTERNATIONAL

Stand C10

**SIAMS**

Halle 1.2 | Stand A24



■ 59 Naxos Way, Keysborough, Victoria 3173  
Ph : +61 451665316  
Email : peter@swisstec.com.au  
Web : www.swisstec.com.au

■ Utilis AG, Precision Tools  
Kreuzlingerstrasse 22, CH-8555 Müllheim  
Phone +41 52 762 62 62, Fax +41 52 762 62 00  
info@utilis.com, www.utilis.com

■ Utilis France SARL, Outils de précision  
90, allée de Glaisy ZI, FR-74300 Thyez  
Téléphone +33 4 50 96 36 30, Téléfax +33 4 50 96 37 93  
contact@utilis.com, www.utilis.com



CAD/CAM for exceptional parts



The MultiSwiss, for a competitive edge



DuAll Part 2: DuAll Precision dives into major streamlining project to keep up with growing demands



Tornos supports growth for precision metrology manufacturer

## IMPRESSUM

Circulation: 16'000 copies  
Available in: Chinese/English/  
French/German/Italian/Portuguese  
for Brazil/Spanish/Swedish

TORNOS S.A.  
Rue Industrielle 111  
CH-2740 Moutier  
www.tornos.com  
Phone ++41 (0)32 494 44 44  
Fax ++41 (0)32 494 49 07

Editing Manager:  
Brice Renggli  
renggli.b@tornos.com

Publishing advisor:  
Pierre-Yves Kohler  
pykohler@eurotec-bi.com

Graphic & Desktop Publishing:  
Claude Mayerat  
CH-2830 Courrendlin  
Phone ++41 (0)79 689 28 45

Printer: AVD GOLDACH  
CH-9403 Goldach  
Phone ++41 (0)71 844 94 44

Contact:  
aeschbacher.j@tornos.com  
www.decomag.ch

## SUMMARY

Listening to our customers	5
CAD/CAM for exceptional parts	7
The hidden "secrets" of MultiSwiss	13
The MultiSwiss, for a competitive edge	19
Rethinking centring...	23
Responsible production...	27
DuAll Part 2: DuAll Precision dives into major streamlining project to keep up with growing demands	31
Tornos supports growth for precision metrology manufacturer	37
Motorex: new storage tanks with pigging technology in operation	41
Mastercam Swiss Expert: 2012 version and satisfied customers	45
Uncommon expertise	49
"Over the top - Multicut Ultra"	51
Tornos commitment to professional training	53

# MIN CUT

Conçu pour une plus grande précision et une haute productivité d'usinage dans les petites pièces



Fournisseur de Rentabilité Maximum



Les nouvelles plaquettes ISCAR dédiées aux gorges frontales et au tournage sont disponibles dans des diamètres de 8 à 17 mm, pour une profondeur de gorges de 9mm maxi. Un seul porte-outil permet de recevoir toutes les géométries de plaquettes.



MIFR pour gorges frontales et copiage



MIFR pour gorges frontales



MITR pour filetage intérieur



MIUR pour dégagements d'angles



MIGR pour gorges intérieures et copiage



MIGR pour gorges intérieures

908

P M K N S H  
✓ ✓ ✓ ✓ ✓

Member IMC Group  
**ISCAR**  
www.iscar.ch



ISCAR TOOL ADVISOR  
www.iscar.com/ita

## LISTENING TO OUR CUSTOMERS

**Retaining our loyal customer base is our top priority. Listening to and understanding your aims and constraints are the values upon which Tornos bases its action.**



In offering a customer-focused market approach, it is our employees' motto always to try to understand before offering a solution. In fact, only by first clearly defining and specifying your requirements and your expectations can we offer you the best of our expertise in terms of our selection of machines, equipment and setups. The desire to respond to your needs is the primary motivation behind our passion for innovation.

A differentiated market approach drives us to focus on 4 main business sectors: automotive, electronics, medical and micromechanics. Our specialists, who have extensive experience in these different sectors, are on hand to assess your specific requirements.

Tornos's desire to extend its business to several machining technologies (single-spindle turning, multipindle turning and milling), as well as surface treatment with Cyklos, creates synergies which greatly enhance the quality of our products and services.

Whether the economic climate is buoyant or the situation is more complicated, the experience and the advice of a supplier like Tornos makes all the difference. Let us help you choose your equipment and solutions. We will do our best to guarantee you success.

We are always happy to help and thank you for your loyalty.

*Hugues Leuzinger  
Sales Director,  
Tornos Southern Europe*

# New spindle centering system Makes your life easier !

Patent pending



## HIGH PRECISION – FAST – SMART

Video >>> [www.wibemo-mowidec.ch](http://www.wibemo-mowidec.ch)



design www.babey-creation.ch

## CAD/CAM FOR EXCEPTIONAL PARTS

Nowadays, automatic turning multi-tasking machines (MTM) have become genuine machining centres which performing turning operations, naturally, but which also perform milling, burnishing, thread whirling, decoration and many other operations. To ensure efficient programming these complex operations, companies have found the need to use a CAD/CAM system to effectively and efficiently program parts. Meeting at atokalpa with Richard Steulet, Bar Turning Manager and Yannick Meyer, Technical Sales Engineer at Productec, supplier of GibbsCAM software.



atokalpa produces very small runs of parts for some of the most prestigious watch movements in the world, for example the titanium balance for the Parmigiani Bugatti super sport.

atokalpa specializes in the production of luxury parts, subassemblies and in particular moving parts for the movements of watches for many of the worlds premier watch companies, such as Parmigiani and other prestigious brands. The company is today renowned in this very demanding field thanks to its significant investment in creating, maintaining and developing the necessary expertise and tools

to manufacture these small and high precision parts. This work can be achieved quite efficiently due to the fact that it can rely on a fleet of some twenty different types of automatic turning machine, Richard Steulet states: *"We produce all the very complex high precision parts on Deco 10 machines. This is by far the best machine for this demanding type of work"*.

# atoka l p a

UN SAVOIR-FAIRE  
MICROTECHNIQUE  
AU SERVICE DE  
L'HORLOGERIE  
DE LUXE



Integration of GibbsCAM and the TB-Deco is optimal, Richard Steulet wouldn't want to go back to previous working methods.

## WHAT DO I DO IF I NEED HELP?

When you purchase GibbsCAM, Productec offers a maintenance contract which includes comprehensive support, including:

- Telephone hotline and e-mail assistance;
- Possibility to submit programmed parts for personalized assistance;
- Remote PC support for customers;
- On-site guarantee of post-processor operation;
- 1 update CD per year.

Richard Steulet states: *"The service works well, the Productec team are experts in their field and they have always dealt with our enquiries quickly and efficiently."*



Richard Steulet works on a 15" laptop and programming is comfortable. The only constraint is finding a PC which is powerful enough (2 Ghz processor, 2 Gb Ram and 512 Mb graphics card).

WWW.ATOKALPA.CH



**Fully equipped machines**

To produce parts such as the titanium or CuBe balance with precision in the range of +/- 2 µ, the machines are fully equipped, i.e. with 4 or 5 HF spindles and 14 tools on the two plattens (thanks to the Tecko system from Bimu which significantly increases the number of tool positions) and the company takes the greatest care to ensure this. On such parts, which take only 8 minutes to machine, turning is just a minute's work. All the other operations are performed

by interpolating the X/Y/C axes... and it is here that CAD/CAM is the perfect addition to complement the TB-Deco.

**Impressive torque**

Richard Steulet explains: *"We work with the TB-Deco and GibbsCAM to programme our parts. But for complex operations we focus upon GibbsCAM to generate the ISO code which we simply transfer into*





Within the Deco 10 workshop, the machines work 18 hours a day and 6 days a week in a controlled atmosphere. Tolerances of +/- 2 µ are commonplace.

the TB-Deco". Mr. Meyer states: "GibbsCAM is highly modular and atokalpa has chosen to work with a version adapted to our needs which enables us to combine the advantages of the TB-Deco and GibbsCAM". According to Richard Steulet, who has over 15 years' experience in bar turning and has worked on several systems, combining the TB-Deco and GibbsCAM is by far the best option for producing very elaborate and/or complex parts.

#### How does it work?

The technical department sends the 3D body of the part to be produced to Richard Steulet. He works in GibbsCAM, and because these parts often belong to families of parts, the specialist calls up the processes stored in the software and stipulates which tools to use using the integrated database, then GibbsCAM generates the ISO code. He opens the part in the TB-Deco and applies the code in the relevant operations and it's ready to go. TB-Deco's visualisation tools mean the code's trajectories are controlled

immediately. Richard Steulet adds: "Software does not mean you don't have to think when it comes to the manufacturing process, but it does save us a considerable amount of time. Programming as described above only takes around twenty minutes".

#### Knowledge bases

"We implement new set-ups every day and we are constantly improving our processes. Furthermore, these processes are instantly saved in GibbsCAM so, when producing a part with similar constraints (for example to take into account the deformation of the material in micro machining pockets on balances), the program reuses processes we have already optimised" explains Richard Steulet. In terms of tools, Productec has provided atokalpa with a number of tools in the database to begin and it has been expanded from there. Richard Steulet calls up and modifies these on request. Mr. Meyer adds: "We are very flexible in terms of the solutions we offer our customers. In this case, as atokalpa often uses the



same types of tool and they only changes the dimensions. We have provided them with a customised catalogue and they adapt the tools as necessary". The combination of these two knowledge bases ensures that optimal programming can be performed quickly, easily and accurately.

### Can it be that simple?

Reading the above could make you think that it is very simple to produce such parts. While this is true in part, it is important not to forget the importance of technical experience and expertise in software. Richard Steulet explains: "GibbsCAM really is a very powerful piece of software with a very user-friendly interface. It is true that we work quickly and simply with the powerful NC programming tools GibbsCAM

provides" but, that said, Mr. Meyer states: "Like any program, it is not something one masters overnight and we recommend that our customers undertake training to become proficient in GibbsCAM's numerous NC programming strategies. For bar turners, it's something of a new mindset to acquire a productivity tool like GibbsCAM which once proficient provides an excellent return on the investment as is the case with atokalpa"

### What would happen if GibbsCAM were not available?

"Ideally we use GibbsCAM and the TB-Deco to programme all our complex operations. Anything's possible of course, but working without GibbsCAM would complicate our work considerably and would take us a great deal longer" answers Richard Steulet. He concludes: "I've worked on many systems and with many machines but, for fast and complex set-ups, combining GibbsCAM and the TB-Deco is the best solution to produce very expensive watch parts."



Tonda 1950 Limited Edition

## atokalpa

atokalpa  
Succursale de Alle de  
SFF Composants Horlogers S.A.  
Route de Mi court 2  
Case postale 120  
2942 Alle  
Tel. + 41 32 471 01 40  
Fax +41 32 471 24 75  
info@atokalpa.ch  
www.atokalpa.ch

**PRODUCTEC**  
LOGICIELS ET SERVICES DE PROGRAMMATION CNC

Productec SA  
Grands Champs 5  
2842 Rossemaison  
Tel. + 41 32 421 44 33  
Fax + 41 32 421 44 39  
info@productec.ch  
www.productec.ch

# THE PILLARS OF YOUR PRECISION!



INVEST  
IN YOUR  
SUCCESS!



GWS-shave tool holder

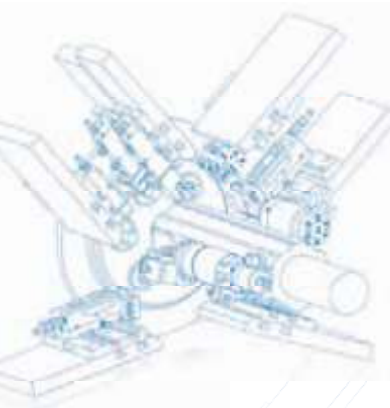

The market demands production which is more and more rapid, flexible and cost-effective. The success lies in reducing the unproductive, tool-related machine downtimes via a presettable and quick-changeable tooling system.

Trust in the proven combination of the GWS-tooling systems and the machines from Tornos!

GWS-tooling systems with pillar-guiding system:

- The most exact positioning
- The highest repeatability
- Large variable adjustment range
- The easiest handling and cleaning

 **Göltebodt**<sup>®</sup>  
Innovation and Precision.

# THE HIDDEN "SECRETS" OF MULTISWISS

In our previous editions of decomagazine we presented the MultiSwiss machine in terms of its performance, design and the customer's point of view. We continue the discovery of this product from behind the scenes: how is its production organised to ensure the combination of constant quality, short lead times, a very good price for the customer, while also recognising ecological concerns? A meeting with Yvan Domin , Assembly Manager at Tornos.

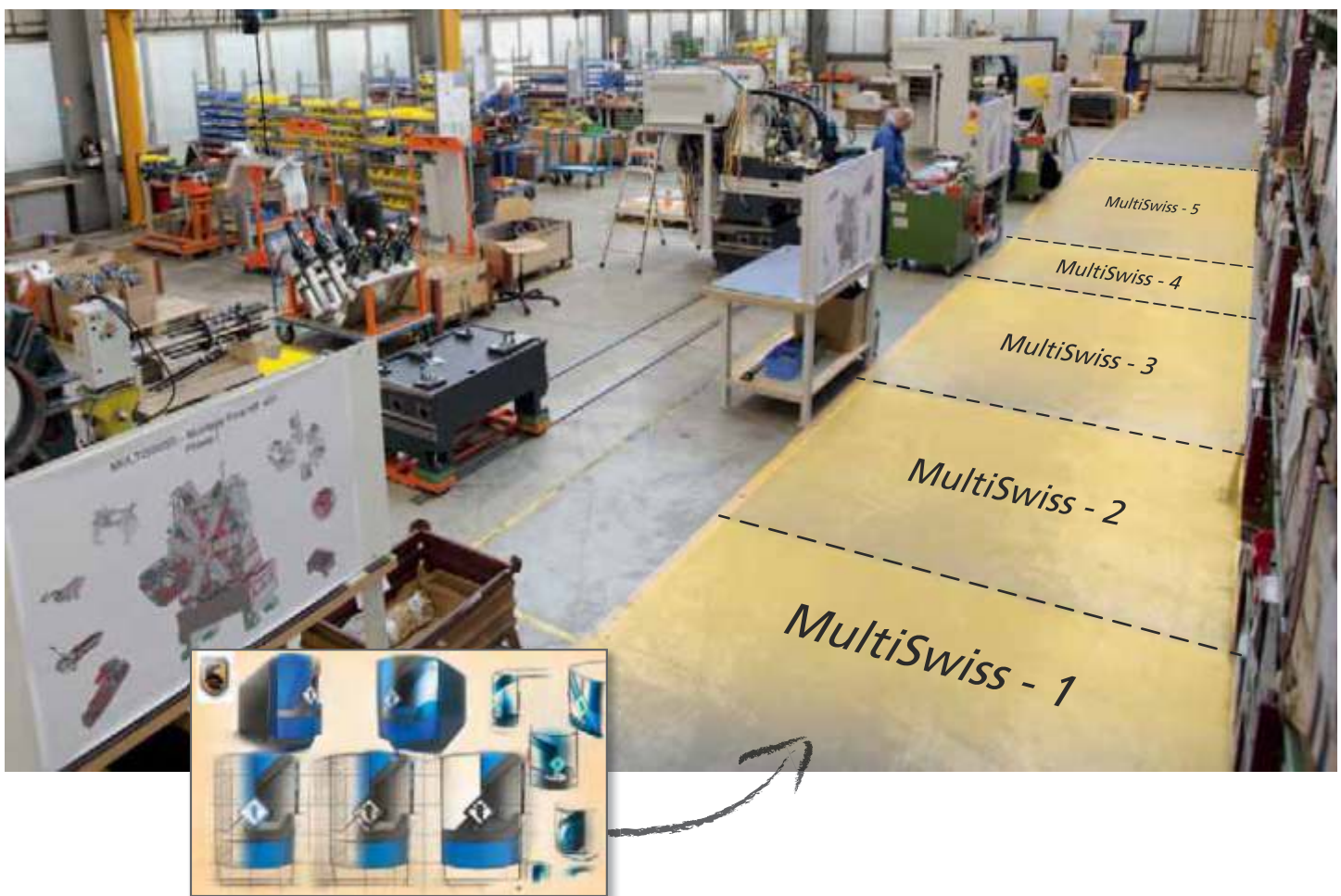

When we visited the MultiSwiss assembly, we were struck by the organisation and neatness prevailing in what is a genuine assembly line. The machines are mounted on carriages running on rails. There are 5 stages in the complete assembly of a MultiSwiss. Each stage takes just one day. If a continuous flow is ensured, every day a new machine will leave the assembly lines. As Mr. Domin remarked: "From the outset, the machine was designed in line with the precepts of Lean Manufacturing, so we have been

able to industrialise its assembly based on this principle. This provides production flexibility, enabling us to perfectly meet the requirements of our customers. If we work in 2 teams, we can produce 10 MultiSwiss machines per week without any problems."

### Major customer benefits

In theory the assembly methods are of little importance to the machine users, but if these methods

## A NEW, RADICALLY DIFFERENT CONCEPT

With the launch of MultiSwiss 6x14, Tornos presented the first numerical sliding headstock multi-spindle machine on the market. Based on a “fully integrated” concept and featuring innovative front access, this new machine offers a resolutely different work approach on a multi-spindle turning machine, generating plenty of enthusiasm among the first customers to try it out.

ensure short lead times, a constant high quality and good prices, they provide maximum benefit. Furthermore, with less fixed capital, the company can invest more in research & development to provide ever more efficient solutions to its customers.

What were the design bases of this production optimisation?

### 7 sources of improvement

“Our aim is to work on sources of waste,” Mr. Domin told us. He explains: “The assembly of a MultiSwiss machine was divided into 3600 sequences of operations which we analysed for the purpose of optimisation, eliminating all so-called “non-added value” operations. Which means: downtime between operations, over-production and surplus stocks, unsuitable methods and processes, pointless movements and transport, and of course quality failures.” By working on all these points from the design stage, the company was able to achieve the objective of reducing the production time of a MultiSwiss by more than 75% compared to other multi-spindle products! A shortened production time also means a smaller floor space requirement.



MultiSwiss - 1

### And what about quality?

If we talk about reducing the production time, we might wonder about the quality, but there is actually an increase in quality. As Mr. Domin explained: *"With a team of specialists, we sought out the best working methods and included checkpoints all along the production line. We drew up detailed procedures for all the work stations. Each assembler knows exactly what they have to do, and how. We demand great rigour from our personnel, and the rules which apply if problems being detected are well defined. Hence we are in perfect control of the production process, and can guarantee perfect quality of our products."*

### Optimum repetitiveness

Each stage of assembly is carried out "just in time", and the specialists can concentrate wholly on their tasks. In practice, the machine arrives at its first assembly area at the same time as all the components required for this stage of assembly. All the tools and devices essential for this point are also on hand. The specialist has an assembly instruction sheet including all the important components, so that assembly can be performed under ideal conditions. Once this assembly stage is complete, the machine can proceed to the next station, where the machine currently at

this second station will also be finished and ready to pass on to the next station (and so on to the end of the line).

### What about for personnel?

This work approach is fairly similar to the automotive industry, and may seem "inhuman" to some people, with these principles bringing to mind for some people visions of the Charlie Chaplin film "Modern Times", since humans are used scientifically as targeted resources in each operation. Mr. Domin told us: *"Work specialisation does not detract from the merit or skills of our staff, quite the opposite. They are well informed about the tasks, and their working conditions are improved. The operations are optimised, enabling the work to be performed with perfect peace of mind. The work is tailored to each individual's skills, and we also promote versatility. Our staff are key assets to our company, we are there to guide them and support them. They actively participate in improving quality by detecting problems and suggesting improvements. We strive to adapt the organisation to the tasks to be performed; it should not impair the quality and efficiency, but boost them. Hence, within an approach of constant improvement, our staff can be proud of their work."*



MultiSwiss - 2



MultiSwiss - 3



## Presentation

### Permanent improvement

The assembly of the MultiSwiss machine is broken down into 3600 processes, all of which have been timed and analysed for optimisation purposes. As Mr. Domin remarked: *“The aim was not to pressure added-value operations at the risk of reducing their quality, but to get rid of all “non-added value” operations, such as pointless movements and wasted time.”* Once the process had been set up, a continuous improvement loop began. After

the pilot run had been completed, nearly 700 processes were improved for a further 15% productivity gain.

### Fully integrated into the production flows

The machine assembly follows a pull system, i.e. an order-only basis. To ensure optimum use of the assembly lines, assembly is planned according to forecasts. Since each major stage takes just one day,

### ARTICLES COVERING MULTISWISS IN DECOMAGAZINE:

- 2012 60 MultiSwiss: customer-focused industrial design
- 2012 60 Motorex - further innovation thanks to the “cutting oil” design factor, the MultiSwiss example
- 2011 59 Flexible “MultiSwiss” multi-spindle machine
- 2011 58 MultiSwiss: A new, radically different concept
- 2011 58 MultiSwiss: A machine that makes working a pleasure

You can request these editions of decomagazine from the following address (FAO Julie Aeschbacher), specifying the language you want; you can also download all these articles from [www.decomag.ch](http://www.decomag.ch).



MultiSwiss - 4



there is maximum flexibility. In this way Tornos is guaranteed a minimum fixed capital (i.e. only producing machines that have been ordered).

### Objectives achieved?

*"When we set up Lean Manufacturing our objectives were simple; we wanted to control the quality and processes, and optimise efficiency (and therefore price), to ultimately eliminate whatever the customer does not pay for (the waste mentioned above). These two objectives have been achieved, and we are in a process of permanent improvement,"* concluded Mr. Domin .

### Responsible production

In our article "Responsible production – Blue Competence" on page 27, we cover aspects of sustainable development and energy savings that users can make by working with Tornos machines. But where does this come from? The new MultiSwiss assembly line is fully in line with this mega-trend. Mr. Domin told us: *"With the optimisation of parts and machines flows, we have completely eradicated pointless movements and transport; furthermore by adapting the workstations we have also eliminated*

*redundancy. All these factors ultimately represent energy savings."* Since assembly requires a much smaller floor space, the ecological balance is very positive in this respect too.

To find out more about MultiSwiss, contact Rocco Martocchia at the address below:  
martocchia.r@tornos.com  
www.multiswiss.info



Tornos SA  
Industrielle 111  
2740 Moutier  
Tel. +41 32 494 44 44  
Fax +41 32 494 49 07  
www.tornos.com

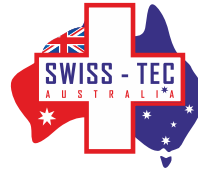

■ 59 Naxos Way, Keysborough, Victoria 3173  
Ph : +61 451665316  
Email : peter@swisstec.com.au  
Web : www.swisstec.com.au



MultiSwiss - 5



**SCHWANOG TOOLS IN ACTION:**

**WE GET EVERYTHING OUT OF YOUR PART!**

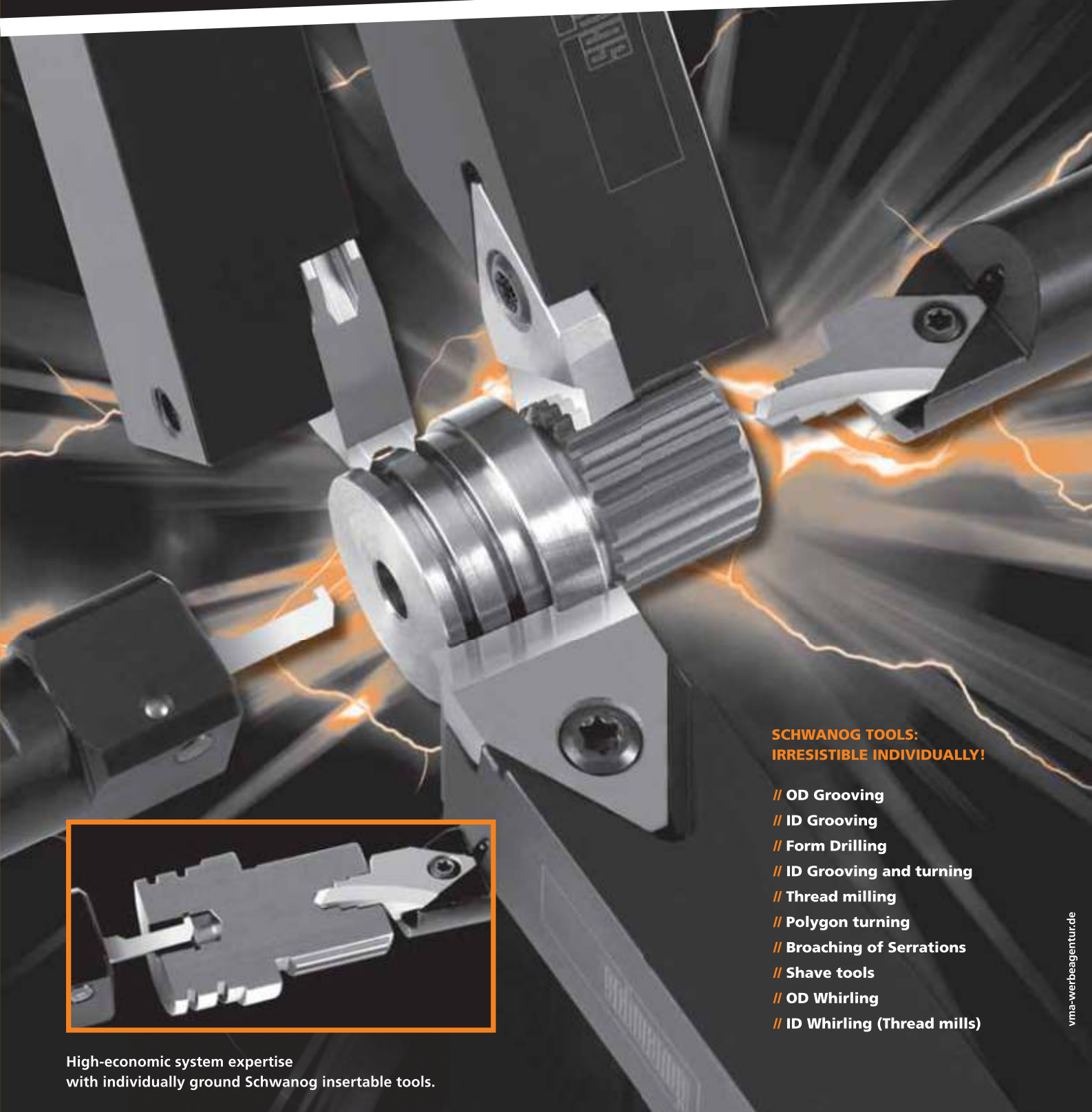

**SCHWANOG TOOLS:  
IRRESISTIBLE INDIVIDUALLY!**

- // OD Grooving
- // ID Grooving
- // Form Drilling
- // ID Grooving and turning
- // Thread milling
- // Polygon turning
- // Broaching of Serrations
- // Shave tools
- // OD Whirling
- // ID Whirling (Thread mills)

High-economic system expertise  
with individually ground Schwanog insertable tools.

[www.schwanog.com](http://www.schwanog.com)



**schwanog**

## THE MULTISWISS, FOR A COMPETITIVE EDGE

Founded in 1967, Nicoletti is a family business based in Trissino (VI) in the Veneto region of Italy and run by Giuseppe, Francesco and Antonio Nicoletti. Today, one generation on, the watchwords upon which the company has built its reputation are the same as ever: quality, flexibility and reliability. Now they are even more deeply rooted in the company's philosophy. When Nicoletti found it was time to replace their cam-type multispindle machine, they naturally thought of Tornos and the MultiSwiss 6x14.



Operating throughout the automotive, hydraulics and gas sectors, Nicoletti has an extensive range of machines. Whatever the needs of the customer, Nicoletti can respond, with diameters from 4 to 150 mm. In its factory covering over 3,000 m<sup>2</sup>, the company has numerical control single-spindle and multispindle turning machines, as well as cam-type machines. Decomag met Luigi Nicoletti, President of Torneria Nicoletti, along with two operators employed by MultiSwiss, to understand how this machine helps the company gain a competitive edge.

### **decomagazine: Why did you approach Tornos?**

**Luigi Nicoletti:** Tornos offers an extensive range of products; the company offers great solutions which cover almost all our needs. Tornos is a machine manufacturer with a true culture of innovation; it regularly launches lots of new products. Tornos also offers an excellent pre- and after-sales service – we feel supported, we are not just a number.

## Interview

**dm: Tell us how you came across the MultiSwiss machine?**

**LN:** It all started at the BIMU 2006 trade show, while we were visiting the Tornos stand. I said I wanted to replace one of our cam-type multispindle machines, and that's when they mentioned a project aiming to create a hybrid machine which would be a cross between the conventional multispindle turning machine and the sliding headstock turning machines capable of delivering cycle times close to those of cam-type multispindle machines. Intrigued, we decided to wait for this promising product to be launched.

**dm: Do you regret having to wait so long?**

**LN:** No, now we own a very sound product which meets all our needs... and more!

**dm: More?**

**LN:** The MultiSwiss is the fastest numerical control machine we know! The quality of the parts is superior to that achieved using our other products, but for us the greatest surprise lies in how unbelievably accessible it is, which facilitates set-up. So much so that it is quicker to change the set-up on the MultiSwiss than it is on our Tornos Delta 20/5. The MultiSwiss enables us not only to achieve greater productivity, but also enhanced quality. We had started produc-

ing machined parts on our cam-type multispindle machines, but we soon realised that the machine was able to cope admirably with small production runs which had up until then been reserved for single-spindle machines.

**dm: The MultiSwiss offers a wealth of technological features, what do you think of the sometimes bold technical choices Tornos has made?**

**LN:** I get the impression that every choice has been weighed up very carefully: the choice of 1.5 m bars, for example, was puzzling at first but, in practice, the ease with which they are changed, and the increased speed of rotation which this solution offers, help to strengthen the machine's performance levels. The decision to house all the peripherals required to operate the machine together inside the container is a real advantage and makes the MultiSwiss a turnkey solution. It is a genuine example of innovation and we have seen the immediate benefits of it.

**dm: Flexibility is a watchword at Nicoletti; how do Tornos and the MultiSwiss fare in this area?**

**LN:** The machine is sound and we are very well supported by the people at Tornos. We work as a team, it is the first machine of its type in Italy, a strong bond unites Tornos and Nicoletti.





**dm: What are the advantages of the MultiSwiss from the operator's point of view?**

**Mr. Roberto:** The MultiSwiss is a machine which inspires confidence; it is easy to learn how to use and exceptionally accessible. To save time, Mr. Emanuele and I share the workload: I take care of the main operations, he is responsible for counter operations. It is very easy to change capacity and the settings of the feeder, it's all very quick on the MultiSwiss. Once the machine has reached the right temperature, it is extremely stable. The fact that the machine uses the same oil for the hydrostatic system and the cooling system considerably simplifies maintenance; there's no need to monitor the viscosity of the oil.



**dm: Finally what does the MultiSwiss offer you?**

**LN:** We have some big-name clients like Bosch Rexroth, Parker and W rth, who are global leaders. They have very strict requirements; they demand the very highest quality products and services from us. The MultiSwiss enables us to produce top quality parts quickly and efficiently. We have set ourselves 3 challenges for the next 3 years. This year, we are in the process of obtaining OHSAS 18001:2007 certification. In 2013 we will be expanding our factory and in 2014 we are planning to obtain ISO 14001 certification in order to continue to ensure customer satisfaction.

We rely on Tornos and innovative products like the MultiSwiss to maintain our growth.



Torneria Nicoletti  
 Via Rovigo 7/9  
 I - 36070 Trissino (VI)  
 Tel. +39 0445 962104  
 Fax +39 0445 490101  
 gg.nicoletti@nicoletti.it  
 www.nicoletti.it

# Walter Dünner SA

SWISS TOOLING PRODUCER  
SINCE 1935

[www.dunner.ch](http://www.dunner.ch)

**High tech for best performance !**

## Amsonic

Precision Cleaning



*Environmentally friendly precision cleaning systems*



**Amsonic AquaJet 21**  
Spray cleaning and  
drying systems



**Amsonic 4100/4400**  
Solvent based ultrasonic  
cleaning systems (A3)



**Amsonic AquaLine**  
Water-based ultrasonic  
cleaning systems

View our complete line of products: [www.amsonic.com](http://www.amsonic.com)

Amsonic Ltd. Switzerland • Zürichstrasse 3 • CH-2504 Biel/Bienne

Phone: +41 (0)32 344 35 00 • Fax: +41 (0)32 344 35 01 • [amsonic.ch@amsonic.com](mailto:amsonic.ch@amsonic.com)

## RETHINKING CENTRING...

When changing the setup or settings on an automatic lathe, operators very often have to recentre the spindles. This operation can be carried out in a host of different ways, which are more or less effective and depend largely on the person carrying them out. Sometimes, the process is so restrictive that operators prefer not to do it at all, thereby generating problems relating to quality, precision and premature wear of tools. Wibemo, a company well-known amongst bar turners, is now offering them an innovative solution. Meeting at Rebeuvelier (Switzerland).



Mowidec-TT installed on a Tornos Deco 10 machine: 1) the sensor-bearing ring and 2) the control unit. The cable which connects the sensor to the unit can withstand the atmosphere in the machining area without any problems.

The Mowidec-TT system, only recently available, has been developed in response to a large number of requests received by the company. Mr. Liechti, from the techno-commercial department, tells us: *"The principle of centring itself has existed for a very long time, we have simply found a way of making it quick and easy"*. Mr. Bendit, the CEO, explains further: *"We collaborated with a bar turning company and the technical university in our region. After 8 months of work, we were able to present the first devices"*. And they have certainly been a success; in just a few weeks, dozens of these devices made their way to bar turning workshops.

### Old habits do not die hard!

Whether employing an optical sight for a bore to bore control or a comparator system or even a boring system, users quickly discovered that the new solution is not only easier to implement, it is also much

faster. Mr. Liechti explains with a smile: *"The only problem we have encountered with test customers is that they didn't want to give us the equipment back!"* Mr. Boillat, also from the techno-commercial department, added: *"Some customers were sceptical as they had already considered a number of alternative solutions. But a simple demonstration was enough to convince them"*.

### Centring in just a few minutes...

Centring is carried out without removing either the guide bush or the tools, and without any complicated equipment or training; it is so simple that users start centring systematically (with major benefits for tool quality and service life). Mr. Liechti quotes us something said by one of his customers when trying out the Mowidec-TT device: *"Why did you wait so long to develop this product? I've been waiting for it for 15 years!"*.

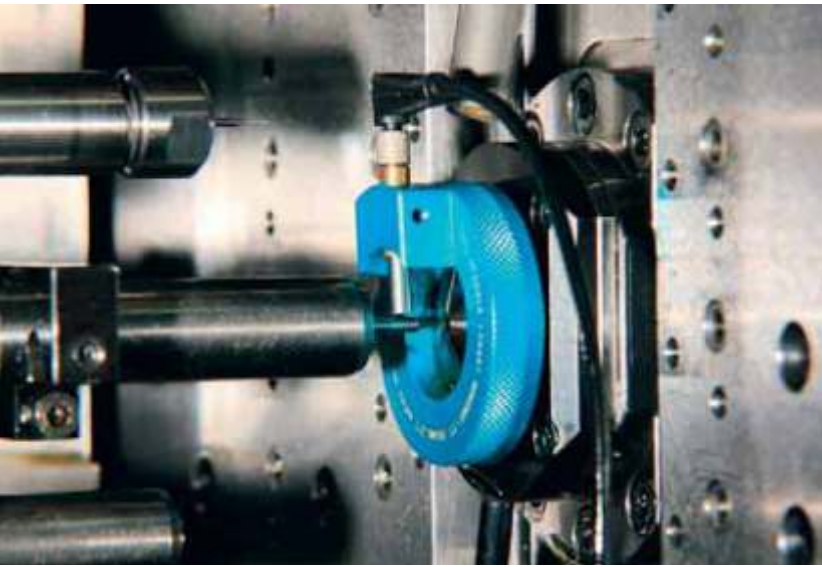

Centring a drilling spindle in main operation. The ring's colour depends on the diameter and makes fitting the device even simpler.

### ...and to the nearest micron

An adaptation ring is fitted on the spindle. This ring contains a contactless transversal sensor. The tool is manually moved opposite the spindle, with the sensor positioned visually at short range. The small magnetically-secured unit is reset to zero. The spindle is turned 180 degrees and the unit shows an error in the diameter vertically. All that remains is to correct the machine offsets by half (radius error), reset the unit to zero and pivot the spindle to its original position. Any residual error appears on the unit to the nearest micron. To correct it horizontally, the spindle is then pivoted 90 degrees and any error is displayed. This axis is then also corrected (either mechanically or using software, depending on the machine).

### Universal use

The operation described above is used to align the drilling spindles in relation to the machine's headstock (main spindle). By simply changing the sensor-bearing ring, it is possible to align the secondary operation machining spindles or even the spindle and counter spindle together (for example, following a collision). Mowidec-TT is compatible with all bar turning machines on the market and the company is selling sets designed for particular types of machine. For example, during my visit, I was able to see the Deco 10/Deco 13 kit. Mr. Boillat explains: *"The system remains the same regardless of the machine, only the adaptation ring is different"*. The sets contain a certain number of rings as standard and a range of models are available as an option. Mr. Liechti adds: *"The system can be used for any instances of an alignment problem. For example, one of my customers immediately saw the benefits for his gear hobbing machines"*. But Wibemo's objectives are clear - the company's main priority is to make the bar turner's life easier.

### Simple and ergonomic

As we saw above, the system is very simple to use and Wibemo has made sure this applies to every aspect. The customer receives a case containing the device, the sensor, the cables and the set of rings. The rings are anodised in different colours according to diameter so they are even simpler to use. The power supply for the little unit is connected using the machine's socket and the sensor is connected to it with a single USB port. The operator attaches the unit wherever he thinks it will be most effective, the ring is fitted and measuring can commence.

As the measurement system is a contactless capacitive system, it is not affected by any oil residue on the parts the sensor is reading.



The centring set comes as a small "turnkey" case which ensures it is quick and easy to start using, giving perfect results in a few minutes.





Fitting on the guide bush. The vertical axis of the sensor must be positioned along the same plane as the vertical axis moving the plattens.



It couldn't be any simpler: the screen shows the error with the diameter to the nearest micron, then simply correcting the offsets compensates for the error. Recentring spindles becomes child's play!

### Exemplary collaboration

*"Next, all that needs to be done is to convert the information provided by the sensor into precise and reliable numerical data",* explains Mr. Liechti. To do this, the company collaborated with the Haute école Arc technical university and a major local bar turning company. Mr. Bendit adds: *"We wanted to offer a truly tried and tested solution and we carried out several test stages with our partners".*

### How will customers be won over?

What is the company doing to convince its customers that its universally patented system is not just another gadget and that they will see immediate benefits? Mr. Liechti explains: *"Actually, it speaks for itself. The product is so simple that just explaining it is enough to convince professionals of the benefits it could bring them".* A video available also allows any interested parties to discover this highly effective system ([www.wibemo-mowidec.ch](http://www.wibemo-mowidec.ch)).

Are you going to keep on centring your spindles the hard way?

## THE ADVANTAGES OF MOWIDEC-TT

- Simple to implement
- Does not require removal of the guide bush
- Centring without removal of tools (saving time and increasing accuracy)
- Quick to use
- Precision to the nearest micron in just a few minutes
- Ensures centring is regular and uniform regardless of the operator
- Universal system using a set of rings

Thanks to Mowidec-TT, centring spindles will once again become a standard operation when changing setups and settings.



Wibemo SA  
Rue Montchemin 12  
2832 Rebeuvelier  
Tel. 032 436 10 50  
Fax. 032 436 10 55  
[info@wibemo.ch](mailto:info@wibemo.ch)  
[www.wibemo.ch](http://www.wibemo.ch)

# Pinces et embouts · Zangen und Endstücke · Collets and end pieces

for

LNS, TRAUB, FMB, IEMCA, CUCCHI  
TORNOS, BECHLER, PETERMANN



**ANDRÉ FREI ET FILS SA**

Rue des Gorges 26  
Tél. +41 32 497 71 30  
www.frei-andre.ch

CH-2738 Court  
Fax +41 32 497 71 35

## RESPONSIBLE PRODUCTION...

**Optimising energy efficiency and the use of resources is playing a growing role in industrial production and how machine tools are constructed. This is especially true as energy becomes more costly and resources dwindle. For more than two years, the German association of machine tool manufacturers, VDW (Verein Deutscher Werkzeugmaschinenfabriken), has been looking at this question quite intensively with the "Blue Competence" project. It is a project in which Tornos is involved.**



Interest in this subject was first raised with the activities of the EU as part of the EuP directive. The European Parliament plans to classify machine tools into energy efficiency categories. Machine tools are considered to be major energy consumers and Europe intends to introduce a similar classification system to that used for washing machines and dryers. The European Committee for Cooperation of the Machine Tool Industry (CECIMO) has set up a counter initiative to promote self-declaration, similar to certification of companies relating to their compliance with EC directives.

### **Exploiting the potential for optimisation**

Due to the multiplicity of parts that can be produced and the different types of machine involved, the energy efficiency improvement and use of resources

aspects are practically unlimited, as it is the system manufacturer's vast experience in terms of the respective processes which allows the environmental and economic aims to be combined into an optimised technical manufacturing entity.

### **Working on the basis of functional modules**

The complex interaction between the machine tool, the influence of the user and the immediate consequences of the product produced on energy consumption clearly show the extent to which it is impossible to make determinations based on implementing measures for individual regulatory requirements aimed at improving the energy efficiency of machine tools.

Its aim is to look at functional modules and units. Putting the optimisation of the different elements to

## The present

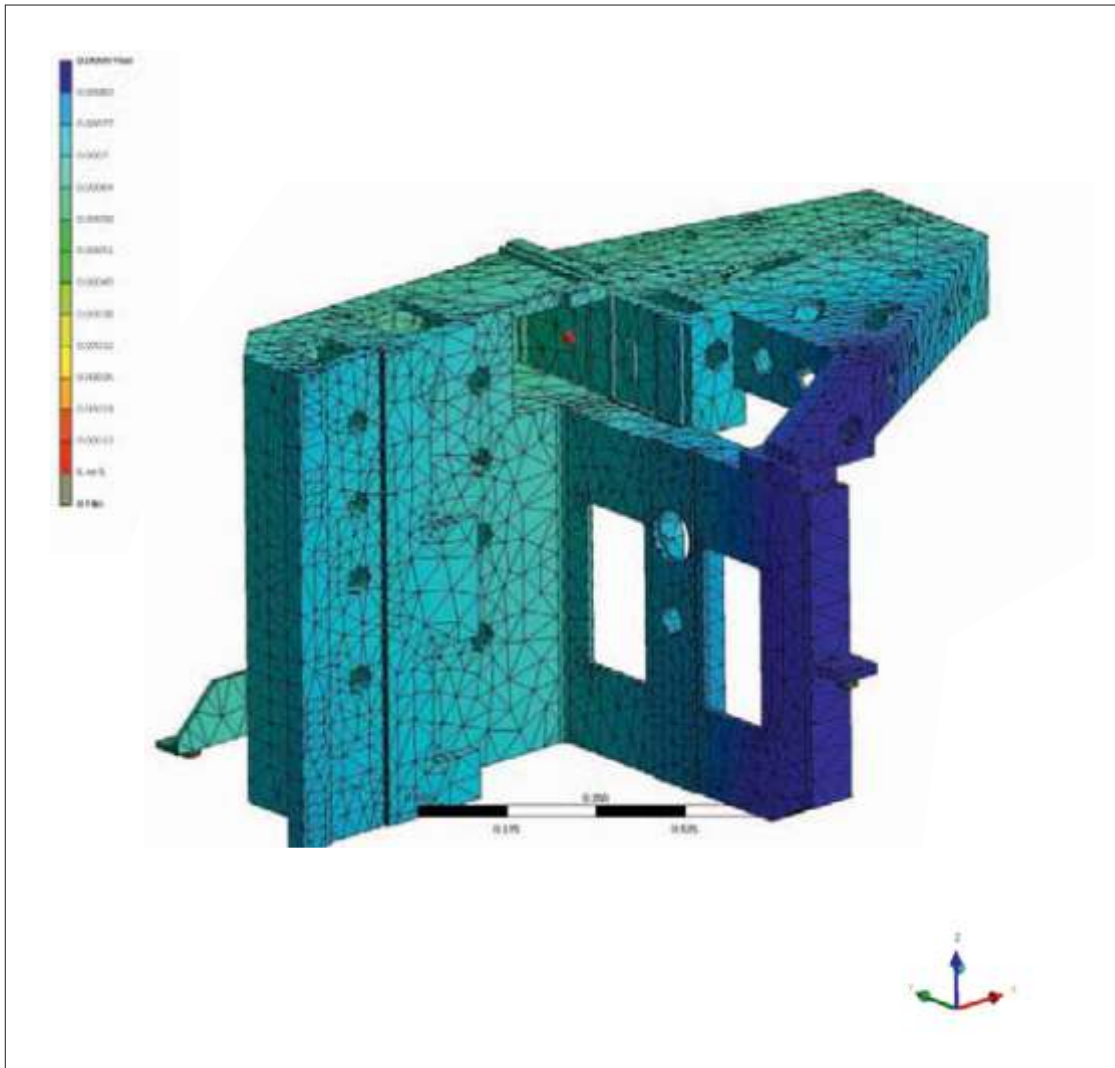

### TWO MACHINES OUT OF FIVE WITH ZERO CONSUMPTION

A complete analysis has been carried out to take all the efficiency points into account.

- Machining with non-optimised consumption: 100%
- Energy consumption with energy recovery: 65%
- Consumption with energy recovery and TB-Deco optimisation: 60.5%

These results are based on tests carried out with an EvoDeco machine where the masses were optimised and the pumps used are low consumers. Compared to a "standard" machine, these savings are even more impressive.

To summarise, the energy savings allow users to run five machines at the non-optimised consumption level of three machines!



one side, this modular approach allows the efficiency potential to be deduced for each constructive type of machine, and also for the systems' inherent potential to be exploited<sup>1</sup>.

#### **Blue competence**

The "Blue Competence" campaign aids the machine tools industry to ensure it is well-positioned as regards both policy and public. The explicit requirements of the technical and organisational plan relating to an ecological way of thinking and acting within the company allows partner firms which are members of the association to benefit from this marking.

### **THE TORNOS EXAMPLE WITH EVODECO**

#### **Deco energy optimisation**

Since as far back as 1996, Tornos has been anticipating this trend with Deco machines and their energy optimisation system which reduces unnecessary acceleration and braking by bringing the tools to where they are needed "just in time". In fact, TB-Deco calculates the minimum feed rate of each tool indexing procedure without modifying the cycle time of the part. It is therefore possible to reduce electrical consumption by almost 7%. This technology is, of course, always up-to-date, preserving the mechanisms and reducing wear.

#### **Synchronous motors and energy recovery**

The use of more efficient synchronous motors improves machining performance on spindles and on

the majority of the axes. Thanks to the drive modules, the machine recovers and reinjects up to 70% of the energy released by braking into all the drives.

#### **Pump actuation using a frequency converter**

The use of frequency converters on high pressure pumps makes it possible to optimise the machining fluid supply. Permanent fine adaptation of the pump motor's rotation speed makes it possible to supply only the amount of lubricant that is strictly necessary. This results in a massive reduction in the electrical energy taken from the network and in significant cost savings.

#### **Reduction in moving masses**

For many years, Tornos has digitally calculated and optimised the behaviour of the key components of these machines. These analyses using finished elements have enabled engineers to reduce the moving masses and therefore reduce energy consumption whilst improving acceleration. These analysis methods allow us to reduce masses by up to 40% whilst improving machining performance.

#### **Good for the environment, and more...!**

The areas outlined above clearly show that the environmental benefits are fully compatible with the economic imperatives. Producing with an EvoDeco is not only a responsible way of working, but also a money-saving one.

<sup>1</sup> For this reason, a normalisation project was launched as part of ISO/TC 39 "Environmental evaluation of machine tools" aimed at evaluating machine tools from an eco-design perspective.



## New CoroDrill®870 Not just different, outstanding!

Exchangeable-tip drills have been around a while, they are nothing new. Neither are the problems they can have. CoroDrill 870 is something different, a whole lot different, a new generation of exchangeable-tip drill.

So how is it different? Well, we fixed the interface between drill body and tip. It fits perfectly and securely so you don't have to worry about precision being an issue.

Changing the tip is fool proof, (you could probably do it blindfolded, although we don't recommend it), maximizing actual machining time.

A smart drill flute design together with the geometry makes light work of chip evacuation.

We made sure the design optimizes your applications through diameter range, steps, and length possibilities, so holes can be made more efficiently and closer to your requirements, leaving them better prepared for the next job.

Oh yes and with the new grade you won't have to swap the tip that often.



Scan the code and read more tips  
for improved holmaking!

**SANDVIK**  
Coromant

Your success in focus

[www.sandvik.coromant.com/ch](http://www.sandvik.coromant.com/ch)

## DUALL PART 2: DUALL PRECISION DIVES INTO MAJOR STREAMLINING PROJECT TO KEEP UP WITH GROWING DEMANDS

In early 2007, decomagazine visited DuAll Precision in Addison, Illinois, USA. The company was transitioning from multi-step processing to a more modern, single-setup manufacturing organization. Their nine Tornos Deco machines had been cutting hydraulic parts non-stop, six days a week since they were purchased in 2002.

And they were just installing two Tornos Sigma machines to handle simpler geometries, freeing up time on the Decos for their most complex parts. Back in 2007, Mike Butler, DuAll President, predicted that Tornos was going to play a very major role in his company's future. He was spot on.



Bogie Bartel, Manufacturing Engineer (and part-time scuba dive and ski instructor), has seen a lot of changes in the seven years he's been part of the DuAll team. He's actually coordinated many of them. Recently, decomagazine sat down with Bartel and DuAll President Mike Butler, to talk about the impressive changes they have implemented since we last spoke.

*"We grew a little bit,"* states Bartel modestly. *"Actually we grew enough that we had to find another building. We added about twenty people and ten Tornos machines."*

Last year, DuAll engineered a plan to split their machining operations into two buildings – one space with all their CNC conventional equipment, and the other dedicated to their Swiss machines. Says Bartel, *"We moved all the bigger machinery over to the other space at the end of 2011. The other building is about 30,000 square feet. So there is a really big potential for growth. If our customers give us more orders... we're going to grow with them."*

Preparations to get the building ready for move-in took a little over three months. Then, DuAll transferred two machines at a time so they could

## Presentation



The new Tornos stations in DuAll's Swiss building optimize operator comfort and efficiency.



maintain production demands being managed by Stanley Boksa, DuAll Vice President. The move was an amazing team effort from everyone at DuAll. Bartel orchestrated the relocation tasks of taking pairs of machines offline, moving them, aligning them and setting them up, and then getting them running before beginning with the next pair. Altogether DuAll migrated 12 machines. *"But I got very impatient,"* says Bartel. *"One day we put in six. It was the end of the year and a lot of companies shut down; but we kept working throughout the holiday. We wanted to move everything to the new facility so we could start in January full swing."*

Never ones to shy away from a challenge, the DuAll team's list of recent accomplishments is amazing. Under Bartel's supervision, they began by overhauling the shipping/receiving department – Bartel utilizing his teaching skills to help train that team to act as the final inspection for the company. Bartel also worked with Tornos to create a "400 Level" Advanced TB Deco training program for their Swiss operators (and he's working on a preventive maintenance certification program too). The team also organized the tool crib; implemented traceability systems on the machines and parts inventories; rearranged all the company's machine tool stations to optimize operator comfort and efficiency; installed all new bright, energy-efficient lighting and a state-of-the-art mist



DuAll's inspection department advancements include fast optical scanning equipment necessary to keep up with the high productivity and extreme precision of the Tornos Swiss parts being made at DuAll.





Examples of complex hydraulic parts being made at DuAll.



DuAll Partners Mike Butler and Stanley Boksa (right to left).



collection/air quality system; resurfaced all the floors in the facility; and even found time to update the company website and secure a new corporate logo. But the biggest change of all was creating the dedicated Swiss facility, and moving their entire CNC machining operation down the street into the second building.

### Time for change

To illustrate the transformation DuAll has seen over its 20-year history, Bartel directs the tour to the far side of the Swiss building. *"Let me show you how DuAll started. We began with cam-driven equipment making simple parts. With these old cam machines, it's all about timing."* The line of cam machines stands in stark contrast to the line-up of brand new Tornos machines across the aisle. Like Bartel's favorite place to scuba dive, Bonne Terre mine, where divers can see history preserved, (the old mine an abandoned, yet interesting relic with sticks of unlit dynamite waiting for fire that will never come) the cam-machine aisle at DuAll offers visitors an opportunity to marvel at the past as they cruise by and then surface to see what amazing things technology allows them to do today.

*"There's no market for this old cam equipment,"* Bartel laments. *"That was the past..."* he motions to the cam machines. *"This..."* he pauses dramatically and smiles, *"... is the future,"* he says pointing to all the gleaming blue and white Tornos single spindle machines.

### Business was increasing... and increasingly complex

The use of hydraulics continues to be the industry standard for creating a lot of power; and one only need ask Butler, Boksa, or Bartel how business is going to verify the health of the market segment. But things are changing for hydraulics; and DuAll is seeing big advancements taking place. Customers are combining parts — what used to be two pieces that fit together are now single-piece part designs which are far more complex. DuAll has faced the challenges head-on; and, as a result, continues to have more and more work directed their way.

*"With that complexity came greater precision,"* explains Bartel. *"Where we used to talk +/- one tenth, now we're talking millionths. All of a sudden +/- 50 microns became the norm."* DuAll relies heavily on their fleet of Tornos Deco machines to get the job done. Bartel continues, *"As we're talking about faster cycle times, faster machines, and faster*

## Presentation



turnaround times, we need to talk about much quicker inspection methods too."

"We rely more on statistics all the time to control our processes," adds Butler. "We've expanded our quality control department to meet larger demands." The new Hommel optical scanning equipment installed at DuAll can measure 40+ dimensions on a part in about 15 seconds. So all those complex parts being produced in lots sizes of 25-50,000 on the Tornos machines can be quickly and very accurately inspected and shipped off to the customer.

"Tornos remains a major force for us," explains Butler. "It's a very modern company and they build a great machine tool. They have good vision. The company has been a tremendous contributor to our abilities to give the customer the quality parts they demand."

Bartel agrees, then says, "We've been talking about the machinery here; but another aspect which is very important to us is the technical support that Tornos has provided. They have very knowledgeable service technicians and sales managers that work closely with the application engineers. Andy Stemler and Roland Schutz in particular have been very good to us. Roland's got all the answers that we don't. The Tornos machines don't break down; but when we've needed a technician, Tornos has one here within the next 24 hours. It's not just a great product that we're talking about; but also a great team of people supporting the product. And that is very valuable to us."

### Dipping Their Toes into the Multispindle Market

Lst fall, DuAll travelled to Germany to get a first peek at the revolutionary new MultiSwiss single/multi-spindle hybrid in Hannover. And that visit got them thinking.

"That's a very interesting tool," Butler states with a smile.

"We're toying with the idea of adding a MultiSwiss," Bartel adds. "We're doing research to see if it's the right machine tool for us... researching the applications that we have. Particularly the one we want to run on it. We're working closely with Tornos Engineering – sending them parts for evaluation. And so far the feedback has been very good. It seems we have a good application for the MultiSwiss."

"When we think of multispindle equipment," explains Butler, "it's a market that we're not normally serving. But more and more we find with our Swiss machines that we're actually in the market. Some of our order sizes have grown to numbers that now lend themselves to multispindle equipment."

With bigger demands coming from customers, DuAll wants to be sure they don't have to turn anyone down. To stay competitive in their marketplace, they



Mr. Bogie Bartel, Manufacturing Engineer, part-time scuba dive and ski instructor.



Like Bartel's favorite place to dive, Bonne Terre mine (shown here), visitors to DuAll can see history preserved alongside the modern, Tornos Swiss machine lineup.

need equipment that can produce the highest quality, precise parts in slightly larger quantities.

Bartel elaborates. *"The DuAll philosophy here is to stay with the medium-sized orders – we don't want to go to a million parts a year. We are in the range of maybe 25-50 thousand now. And, looking at this multispindle, I like the quick-change flexibility to go from one application to another... especially when, as a job shop, we have to accommodate a couple different customers. With the MultiSwiss, it looks like we can run very fast, five to ten thousand, and then switch to a different job. And that could help us with our turnaround on parts."* After all, as Bartel points out, that's all they do – sell machine time.

And since the MultiSwiss uses the same TB Deco operator interface as all the Tornos single spindles on their floor, they won't have to dedicate a lot of resources to multispindle training. Which is a big plus for DuAll. They currently cross-train all their Tornos operators on setups and programming. So their team is quite efficient with TB Deco.

*"Our team is very good with TB Deco. And we use it to get the cycle times when we're quoting too. This is a very big advantage. The MultiSwiss seems like a perfect fit for us. Because we don't have to do any extra training – we're going to be pretty much, in my opinion, ready to start using that machine right away."*

DuAll also likes the compact footprint of the MultiSwiss. Even though they've added another building to their operation, they still want to maximize the use of their space – so that, according to Bartel, they can get as many machines as possible.

Butler agrees and summarizes, *"We're always making an attempt to keep our technology up to the very latest industry standards. And the MultiSwiss technology is very attractive to us because of the footprint, the quick changeover capability, and the ability to keep up with our increasing order sizes."*

Butler adds one final observation, *"The ergonomics of the machine tool are also very attractive to our technical people. They like the accessibility of the machining area. They're interested in it. They think it's a very nice looking tool and it excites them."*

Stay tuned for DuAll Part 3. What role will Tornos MultiSwiss play in this successful company's future? Coming to decomagazines near you in 2013...



DuAll Precision, Inc.  
1025 W. National Ave.  
Addison, IL 60101  
Phone: 630-543-4243  
Fax: 630-543-4273  
info@duallusa.com



# HAROLD HABEGGER

## Canons de guidage Führungsbüchsen Guide bushes



### Type/Typ CNC

- Canon non tournant, galets en métal dur
- Évite le grippage axial
- Nicht drehende Führungsbüchse, mit Hartmetallrollen
- Vermeidet das axiale Festsitzen
- Non revolving bush, with carbide rollers
- Avoids any axial seizing-up

### Type/Typ C

- Réglable par l'avant, version courte
- Longueur de chute réduite
- Von vorne eingestellt, kurze Version
- Verkürzte Reststücke
- Adjusted from the front side, short version
- Reduced end piece



### Type/Typ TP

- Réglage par un vérin pneumatique
- 3 positions: travail-serrage-ouverte
- Einstellung durch einen pneumatischen Zylinder
- 3 Positionen: Arbeitsposition-Spannposition-offene Position
- Adjustment by a pneumatic cylinder
- 3 Positions: working-clamping-open

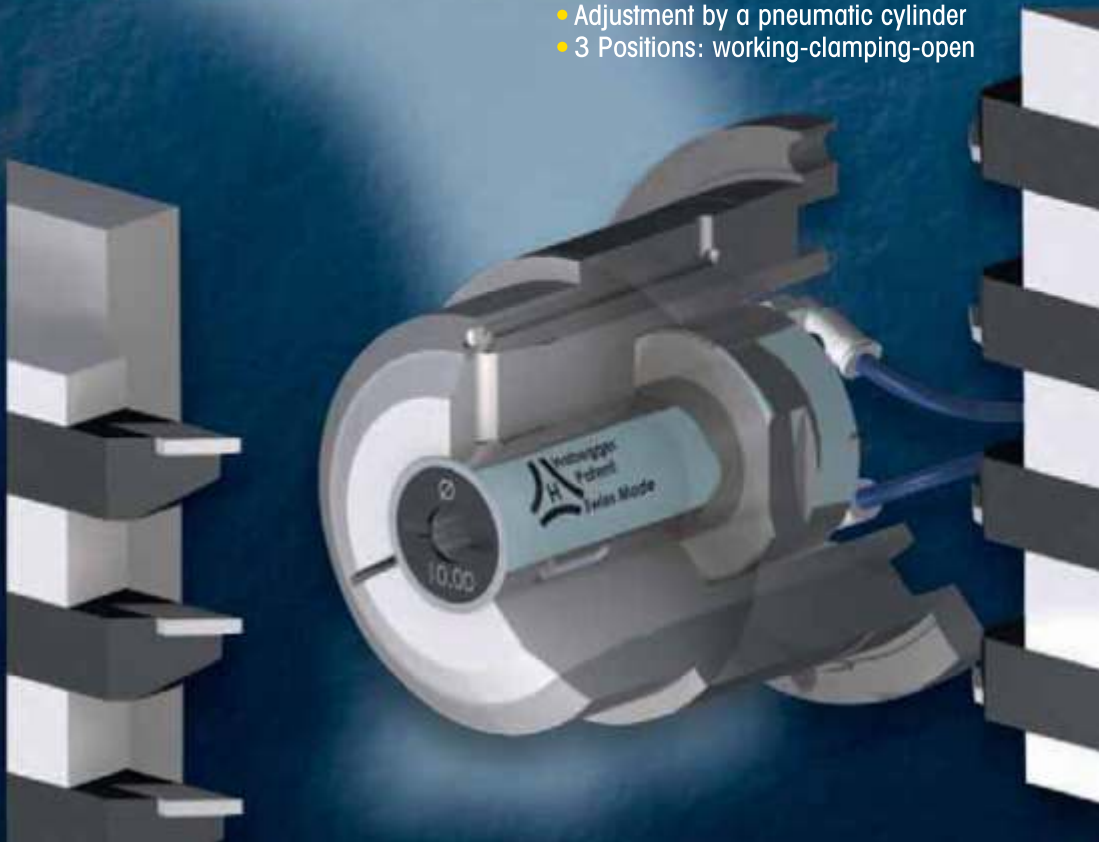

- > 1 Porte-canon: 3 types de canon Habegger!
- > 1 Bibliothèque: 3 Habegger Bibliothèque types!
- > 1 Bushholder: 3 Habegger guide bush types!

## TORNOS SUPPORTS GROWTH FOR PRECISION METROLOGY MANUFACTURER

As a long standing Tornos customer, it was instinctive for Solartron Metrology ([www.solartronmetrology.com](http://www.solartronmetrology.com)) to turn to the leading supplier of sliding head turning centres when its workload and component complexity demands changed. Known as the world leader in the design and manufacture of precision dimensional and position measurement transducers and instrumentation, Solartron acquired its first Tornos machines, three Elector 16 turning centres in 1981. And with the machines standing the test of time with regards to production quality and reliability, the Swiss machine tool manufacturer has once again provided a solution by supplying a Deco 10 and Delta 12/5 in May 2011.



Since the Bognor Regis company was formed in 1973, it has grown to become a Global supplier of measurement products used in a wide variety of applications that include Precision Dimensional Measurement, Multi-channel Electronic Dimensional Gauging, Hand Tools, Positioning Systems, Process Control, Displacement Monitoring and Material Testing for a vast range of industry sectors. In 2008, the company was acquired by the Ametek Group and despite the recession, it has grown significantly over the last 5 years, increasing its staff levels to cope with the increased demand. This growth is credit to Solartron building its business to be extremely responsive to demands for a high variety of lower volume products.

The company purchased further machines, a Tornos TOP200 in 1990, and two Tornos Deco 10 machines in 1999 to support its steady growth.

When Solartron commenced with its plans to buy new turning centres the company naturally reviewed the market thoroughly. As Solartron's Technical Manager, Mr. Peter Shepherd comments: *"Despite being a Tornos customer; as part of a global group we had to engage in a tendering process with potential machine tool suppliers. The confidence and efficiency of the Tornos team to offer a 'best fit' solution to our varied component demands led to us buy a Sigma 20 in 2008. This machine replaced our three*

## Technical



ageing Tornos Elector machines, demonstrating its capabilities to machine all our stainless steel components.

The Sigma 20 managed to replace three machines with its overlapping operations and reduced chip-to-chip times. As the company runs double shifts, five days a week, the Sigma has been running for 21 hours a day for three years. The Sigma was specified for its ability to accommodate fast changeovers, which the company demands for its vast families of parts that are produced in batches from 50 to 5000. Proving a resounding success for the company, the influx of work led the company to add a Deco 10 and

a Delta 12 to its plant list earlier this year. The two additions were bought for machining specific families of parts of varying complexity, with the Deco 10 machining the more complex parts and fitting in as a replacement for an unreliable and ageing competitor machine.

The Sigma 20 has not only improved reliability but with its high pressure through coolant of 120 bar, it has slashed cycle times from 9 minutes to 1.5 minutes. Meanwhile all parts machined on the Sigma are produced in less than two minutes, an exceptional saving considering all parts were previously machined in times ranging from 4 to 9 minutes. Additionally,





*the new Deco 10 is estimated to be at least 40% faster than its predecessor, saving Solartron 3 hours out of each 8 hour shift. A staggering seven hours a day.*

*The company machines bar as small as 1 mm and up to 20 mm diameter. For this, Tornos supplied the LNS Triton barfeed system on the Delta and Deco. This is specifically for the feeding of small bar stock and to eliminate any vibration and guarantee the bar feeding process is on par with the accuracy of the machines." As Mr Shepherd continues: "We are machining our parts to tolerances of less than 10 microns with some dimensions having a finished tolerance of 5 micron. The parts we machine are incorporated into metrology assemblies that have many sub-micron tolerances, so accuracy and quality is paramount.*

*The addition of the Sigma, Delta 12 and Deco 10 has enabled Solartron to eliminate second operations that were a necessity for parts previously machined on alternate machines. This has improved component quality and statistical process control whilst reducing cycle times and inventory, with the company now drastically reducing its stock levels."*

*The new acquisitions at Solartron have substantially reduced subcontracting costs whilst ensuring the company retains full control over the quality of its components. Mr. Shepherd concludes: "The new Tornos machines have made savings and improved our processes in ways we couldn't foresee. The remarkable productivity levels of the machines will ensure that they pay for themselves within two years.*

*As our company continues to grow, I am confident that Tornos will support us in this growth with excellent service, support and solutions to our machining needs."*



Solartron Metrology  
 Steyning Way  
 Bognor Regis, West Sussex  
 PO22 9ST. – UK

Solartron Metrology an AMETEK  
 Company  
 Tel. +44 (0) 1243 833380  
 peter.shepherd@ametec.co.uk

**PIBOMULTI**

SWISS MADE

JAMBE-DUCOMMUN 18  
 CH-2400 LE LOCLE  
 TEL +41(0)32 933 06 33  
 FAX +41(0)32 933 06 30

[www.pibomulti.com](http://www.pibomulti.com) - [info@pibomulti.com](mailto:info@pibomulti.com)

### Specific equipment and accessories for lathes

TTE 10X5 18'000 rpm  
 Integrated ratio : 1 to 5



Minispindle Extensions  
 Ø5.0 mm collets Ø2.0 mm



6 spindles multispindle head



Multispindle head  
 small spindle  
 axis distance  
 4 mm  
 revolution  
 15'000 rpm



Synchronous  
 multispindles Head

Modular spindles  
 for presetting outside  
 of machine

**PIBOMULTI**

SWISS MADE

**BMRC**

### Specific equipment and accessories for TORNOS machines

**PIBOMULTI**

SWISS MADE



Hobbing unit  
 for making gears



Polyvalent drilling and milling head  
 for heavy machining with speed-reducer  
 Usable with or without over-arm



Adjustable angle head  
 with range of adjustability  
 from 0 to 90°  
 5 mm clamping capacity



Axial spindle speeder  
 8 mm clamping capacity  
 30'000 rpm



Right angle spindle speeder  
 5 mm clamping capacity  
 15'000 rpm



Whirling machine

**ASK FOR OUR FULL RANGE CATALOGUE !**

Milling head - Spindle speeder - Angular head  
 Whirling machine - Drilling heads ....

**PIBOMULTI**

SWISS MADE

Mini-Pendelhalter MPH

Zange ER 8  
 Spannbereich 0.5-5 mm  
 Pendelweg 0.25 mm

Petit Mandrins Flottant MPH

Pince ER 8  
 Capacité de serrage 0.5-5 mm  
 Oscillation 0.25 mm

Small Floating Chuck MPH

Collet ER 8  
 Clamping range 0.5-5 mm  
 Floating range 0.25 mm

**stampfli**

PRECISION TOOLS

Andreas Stampfli · Solothurnstrasse 24f · 3422 Kirchberg · Switzerland · Phone ++41 34 445 57 67 · Fax +41 34 445 67 29 · [www.andreas-stampfli.ch](http://www.andreas-stampfli.ch)



## MOTOREX: NEW STORAGE TANKS WITH PIGGING TECHNOLOGY IN OPERATION

The simultaneous filling, producing and emptying in several mixing facilities is a highly complex operation. The storage tanks play a central role in this. With the increased number of storage tanks and the introduction of the most recent generation of pigging technology, Motorex is again expanding its innovative infrastructure. The commissioning of the new plant took place recently.



As is the case with a talented chef who intends to create a delicious menu, he will need, depending on the number of courses and size of the group, quite a lot of pots, pans, bain marie pans, serving plates, etc. Similarly, when it comes to the production of over 2500 different Motorex products more or less the same principle applies. The storage tanks are of central importance in this process. It supplies the mixer with the required raw materials. Depending on the recipe, semi-finished goods are produced which in turn are stored temporarily in a tank and then finished goods are produced afterwards. Even finished products that after production cannot be immediately filled into containers in the large and small bottling department must be temporarily stored in tanks for short periods.

### Increasing flexibility

With 8000 m<sup>3</sup>, Motorex has the largest basic oil stock in Switzerland. Moreover, additives, semi-finished

products and finished products are stored separately in tanks according to type families. Ten additional 1, 2 and 4-chamber tanks that offer an additional storage volume of 500 m<sup>3</sup> for 28 different products have now been added. This enables us to temporarily store certain products before commencing with the filling process and thereby to optimise the capacity of the mixing plant. Optimisation of the production sequence is also taking place. These structural measures have steadily increased the flexibility in production and increase the benefit to the customer of an already high delivery capacity.

### Response to increased demand

Over the past 95 years, Motorex has steadily grown and has continuously invested in production equipment. The company has always focussed on innovative production technologies and infrastructure. With the goal of serving the customer even better and to reduce the impact on the environment wherever

## The present



Photo: I.S.T. Moeltechtechnik GmbH, Hamburg

Thanks to "pigging", time-intensive rinsing processes and the resulting longer production down-times are now a thing of the past.

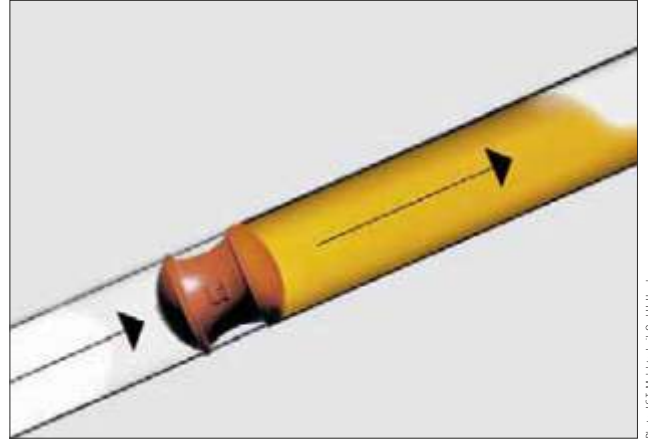

Photo: I.S.T. Moeltechtechnik GmbH, Hamburg

The plastic pig is forced through the pipes and fittings using compressed air and cleans out remaining contents in the pipes without leaving residues.

possible, Motorex was quickly bestowed with the role as innovator in the sector. Through increasing the number of storage tanks, Motorex has not only achieved greater production capacities but also created space for finished products from the industrial product range from Swissline which are now required ever more quickly. Today it is possible to supply the well-known Ortho cutting oil NF-X, TX or S from stock to customers even in large quantities for transport in tank wagons or containers. The most modern infrastructure also makes production of the cutting fluids with integrated PMC® technology possible in completely new dimensions.

### To new heights and yet enclosed

The 10 new tanks were built in the production area in Langenthal on the pre-existing 2 levels of horizontal tanks. This allows the existing secondary container and the space to be ideally used. The whole tract

with a total of 30 horizontal tanks is newly furnished with a building envelope. This allows the waste heat to be used from products that are pumped out of the mixers and into the storage tanks while still warm. Every degree of heat above the ambient temperature that is supplied to the tanks improves the pumpability of the liquids. This in turn enables the medium to be transferred more quickly even at low outside winter temperatures. The recirculation of the waste heat into the roofed storage tanks not only saves time, but also significant amounts of energy.

### Pigging system also helps to save

Upstream and downstream of production, there are soon a few hundred litres of medium in the lines and fittings between the tanks, bottling plant and mixer. So that these lines can be completely cleaned for the next production batch without residues remaining, many of the plants must carry out rinsing processes. These processes are time-intensive and cause waste and quickly incur high costs. During the "pigging process", the contents of the pipelines is forced out using a fitting body made of flexible special plastic (pig) and a propellant, primarily compressed air or in rare cases even nitrogen in order to reduce the risk of explosion. This permits the lines and fittings to be almost completely emptied. This also allows the entire production quantity to be used. This procedure increases production capacities by quickly cleaning the piping systems without leaving residue and means laborious rinsing processes are not necessary.



Plastic pigs like this are shot through the pipes and fittings using compressed air and collected again at the other end.



With the new fully enclosed storage tanks with pigging technology, Motorex emphasises once again its dedication to quality as leading Swiss lubrication technology specialist.



The tank facilities are an important component of the precisely defined extensive production procedures carried out by Motorex in accordance with ISO standards.

### Investments that pay off

When planning the design of production facilities it is always worth clarifying the option of having a pigging system. A piping system that is suitable for "pigging" costs 1/3 more than a conventional pipeline system. For environmental reasons alone, this investment in the future is worth it. Extension of the storage tanks at Motorex with the new pigging system therefore entailed using exclusively chromium steel for the lines. The pig for this system is sent pneumatically through the respective lines to be cleaned and can be directed into the desired line using branching-off fittings. Control and monitoring of the entire pigging process is done using a software enhancement of the pre-existing process guidance system.

With the extension of the storage tanks, Motorex has shown again through the expanded, highly innovative production location at Langenthal that the idea of quality has been consistently implemented since its first production step and has therefore created the ideal conditions for unimpeded further growth.

We would be delighted to provide you with information about the current generation of Motorex metalworking fluids and the options for optimisation within your area of application:



The ground-breaking Motorex industrial products from Swissline are used worldwide by customers in different sectors with success.



Motorex AG Langenthal  
 After-sales service  
 Postfach  
 CH-4901 Langenthal  
 Tel. +41 (0)62 919 74 74  
 Fax +41 (0)62 919 76 96  
[www.motorex.com](http://www.motorex.com)

# Mastercam Swiss Expert



Mastercam Swiss Expert delivers everything you need to make the most of your Swiss machine, including:

- ✓ Solids-based programming precision.
- ✓ Easily read in and machine families of parts.
- ✓ Full support for gang, turret, and sub-spindle programming.
- ✓ Immediate machine simulation, letting you see your finished job before it goes to the shop floor.
- ✓ Support for unlimited programming streams.
- ✓ Powerful synchronization tools for complete control over your streams.
- ✓ G-code editor tailored to a multi-stream Swiss environment.

**cnc software, inc.**

Tolland, CT 06084 USA  
Call (800) 228-2877  
www.mastercam.com

CNC Software Europe SA  
CH - 2900 Porrentruy, Switzerland  
www.mastercamswissexpert.com

certified for DECO [a-line] by **TORNOS** 

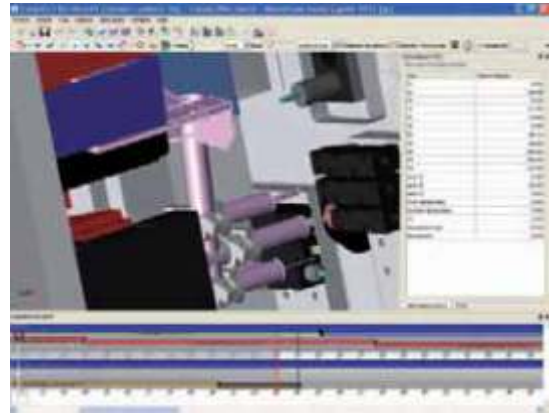

Management of a collision on EvoDECO 10a

**Jinfo**

CH - 2900 Porrentruy, Switzerland  
Call +41 32 465 50 60  
www.jinfo.ch

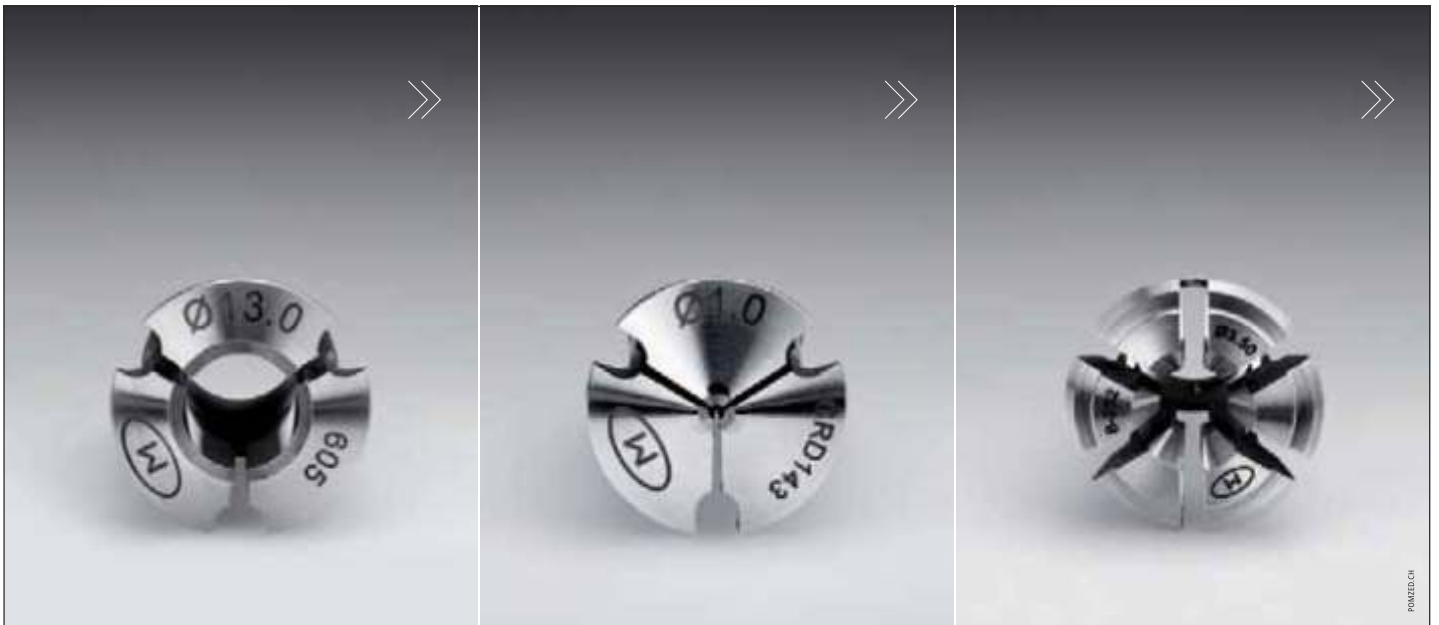

ROUTE DE CHALUET 8  
CH-2738 COURT  
SWITZERLAND  
T +41 32 497 71 20  
F +41 32 497 71 29  
INFO@MEISTER-SA.CH  
WWW.MEISTER-SA.CH



**serge meister**  **sa**

P R E C I S I O N C A R B I D E T O O L S

# MASTERCAM SWISS EXPERT: 2012 VERSION AND SATISFIED CUSTOMERS

**Since the establishment of CNC Software Europe SA in April 2011, the development team has really filled out in Porrentruy, Switzerland and in Tolland, USA. The extension of the dealers network has continued, and indeed the 2012 version is now being used to control the new EvoDECO line.**

## New in the 2012 version

The perfect collaboration between development team members in Switzerland and in the USA has harnessed trade skills relating to turning machines from Europe, and experience in machining algorithms of the biggest CAM publisher from the USA. This high-performance alliance will give rise to the 2012 version of Mastercam Swiss Expert this summer. This version is, of course, aimed at controlling new turning machines, sometimes equipped with a B axis for positioning the tool and machining with this 5th axis. Machining parts with increasing complex geometry on these turning machines also requires CAM machining operations with 3, 4 or 5 simultaneous axes. In these cases, manual programming is no longer possible, and Mastercam Swiss Expert becomes the essential tool for the bar turner to use. The 2012 pre-version is currently being tested on customer premises in order to validate the control of the new EvoDECO line.

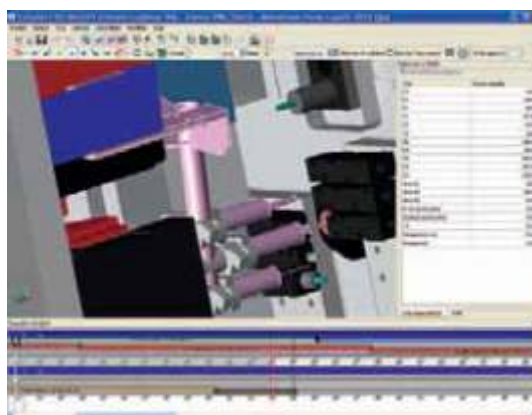

Collision detection on EvoDECO 10a.

moved, the bar turner will realise at this stage, before the operation is started on the machine. S/he can also optimise the work between the main and secondary spindles, and calculate the machining time.

## Importing 3D parts and CAD module

One of the strong points of the new version is the improved importing of 3D volumes from various CADs. Indeed, sometimes the 3D model imported into CAM contains design inaccuracies. The 2012 version features automatic repair of 3D models upon importing. Furthermore, the STEP format recovery interface is included in the price of the basic version, and will be delivered free of charge to customers under maintenance contract.

An additional CAD module is available in addition to Mastercam Swiss Expert. Indeed, for users without 3D CAD, CNC Software offers the CAD sold with its Mastercam solution, for a very attractive price.

## TB-DECO: standard or extensive resources

The philosophy of Mastercam Swiss Expert is to generate the NC code most closely meeting the wishes of the bar turners, including the constraints, synchronisations and axis locking. In the 2012 version, the



Controlling the EvoDECO 10a turning machine.

The more functionalities the automatic turning machine possesses, the better the development on CAM software. With the Mastercam Swiss Expert software, bar turners can work just as if they were at their machine. The simulation is able to detect any collisions and off-strokes. If a tool needs to be

## Technical

user can choose to generate the code for TB-DECO, either by standard programming, or by formatting lines with extensive resources.

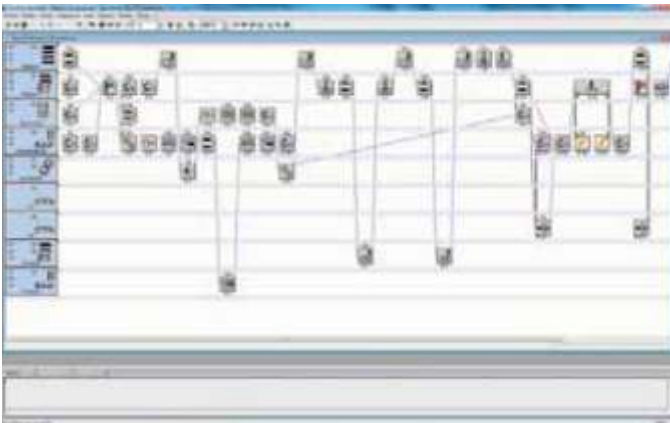

Management of extensive resources in the TB-Deco.

### A host of new functionalities

The 2012 version provides new functions and improves the user interface. Many user requests have been taken into account. These include in particular:

- additional 3, 4 and 5-axis machining operations
- option enabling direct use of threading cable cycles such as G32, G76 or G92 in the operation
- possibility of including rigid tapping with fixed tool in the operation
- sectioning using any machining profile
- additional functionalities in 3D selection of the geometry to be machined
- additional possibilities of positioning the tool for contouring operations.

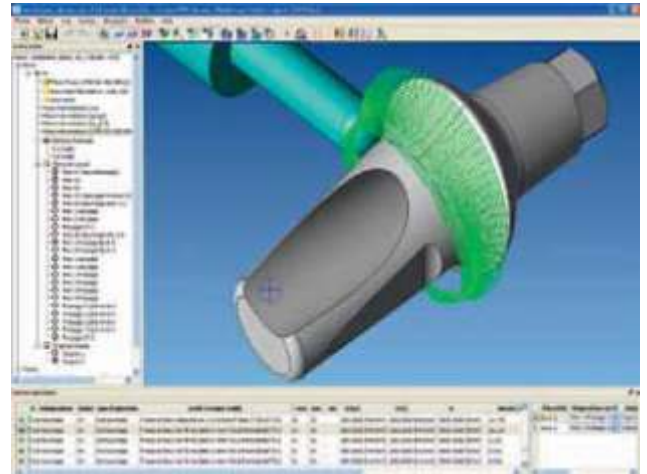

Additional machining operations with 3 simultaneous axes.

### New methodology for training and pre-configuration

Over the past few months, the training methodology has been completely reviewed. Today training on Mastercam Swiss Expert is no longer carried out on a standard machine, but on the customer's machine. Documents tailored to each machine line are supplied to the user. Furthermore, lines of pre-configured models and specific tools are also provided. Programming examples are installed on the customer's machine. The last day of training is dedicated to programming a part chosen by the customer. After training, bar turners may execute their subsequent programs with the help of their personal database.

### Extension of the dealers network

The extension of the Mastercam Swiss Expert technical and sales network is continuing, with 15 dealers being trained in the USA, and several more in France and Belgium. Other certifications are planned in Europe this year. The dealer for Francophone Switzerland, Jinfo SA, will celebrate its 30th anniversary this Autumn. This event will be an opportunity to publish a series of technical and historical articles, as well as customer testimonials.

### Two user testimonials

Jinfo thanks Tectri in Court and Decoparts in La Chaux-de-Fonds for their testimonials on Mastercam Swiss Expert and their partnership.

## TECTRI SA, COURT

Tectri machines complex, high-precision parts within diameters of 1 to 65 mm. *"Our fields of activity are medical, dental and orthopaedic technology, as well as mechatronics, watchmaking, aeronautics and optics. Our materials of choice are titaniums, stainless steel, aluminiums and new high-demand synthetic materials.*

*Our Deco 10a, Deco 13a and Deco 20a machines produce highly machined parts, almost acting as milling centres, thanks to the interpolations available after the spindle has stopped.*

*Our trades and the markets that we serve have become highly dynamic. The development time for a project, prototyping and industrialisation are cut down; the geometries are becoming increasingly complex. Previously, several relatively simple constituent parts were required in order to perform a function; now this function can often be performed with a single complex part.*



Example of parts created at Tectri.

*In order to meet these expectations, we require powerful IT solutions. For bar turning, we opted for Creo Elements/Direct and Mastercam Swiss Expert. The main selection criteria were:*

- *Compiling a relevant tender for complex parts with a short lead time.*
- *Transforming this tender into a CNC program for production machines.*
- *Quick prototyping, the third setting part must be right.*
- *Complete traceability of the manufacturing process.*
- *Involvement of qualified and dynamic personnel.*

*If we are talking IT systems, we take proximity, advice and after-sales service as read. With Jinfo we have personal contacts with whom we have developed relationships beyond the strictly professional."*

Fabien Bouduban,  
Tectri CEO and Owner

## DECOPARTS SA, LA CHAUX-DE-FONDS

Decoparts is a high-precision bar turning company, using numerical machines for the manufacture of high-end watchmaking components and apparatus.

*"Since 2006, I have programmed more than 800 parts with the CAM now known as Mastercam Swiss Expert, on several types of turning machines. All the programs are produced using this solution, from simple parts to the most complex, such as a tourbillon cage calling for extreme precision. Even for simple parts, the advantages over a manual method lie in the speed of creation of the program, especially using the copy-paste function for operations, tools, routes, etc. Furthermore, thanks to use of the 3D model, errors in the machining points are eliminated. This CAM also enables us to perform machining time calculations for costing tenders.*

*I could no longer do my job without Mastercam Swiss Expert. The software has evolved greatly since 2006, in line with what the bar turners have asked for. The Jinfo team has always been highly responsive and efficient."*

Alberto Garcia,  
head of bar turning department



Example of parts created at Decoparts.

---

## **Mastercam Swiss Expert**

published by

**cnc software, inc.**

Tolland, CT 06084 USA  
Call (800) 228-2877  
www.mastercam.com

Development centre dedicated to bar turning:  
**CNC Software Europe SA**  
CH - 2900 Porrentruy, Switzerland

Marketed in Swiss French:  
**Jinfo SA**  
CH - 2900 Porrentruy, Switzerland  
www.jinfo.ch

The perfect complementary solution for TB-DECO

- Optimised for TB-DECO and G-Codes NC machines (Tornos Delta, Micro, Sigma, ...)
- ☒ Optimal solution for swiss turning  
Chosen by watch, medical and automotive manufacturers
- Interactive graphic program optimization

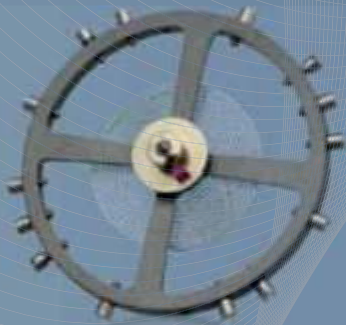
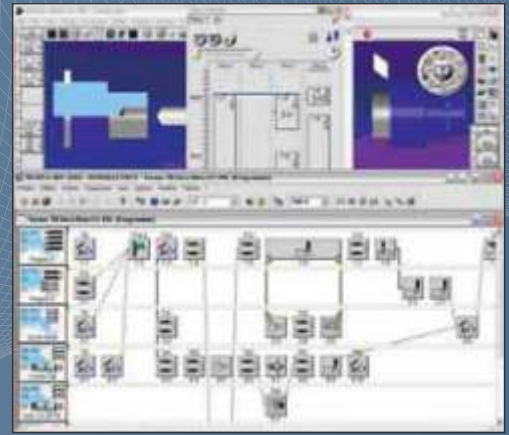

« GibbsCAM is really powerful and user-friendly »  
(Richard Steulet Production Manager atokalpa)

« GibbsCAM is flexible, fast and easy to use »  
(Sébastien Crevoisier Production Manager Bandi SA)



**PRODUCTEC**  
CAD/CAM SOFTWARE AND SERVICES

Switzerland / France  
Productec SA  
CH-2842 ROSSEMAISON  
Phone +41 32 421 44 33  
info@productec.ch

Worldwide  
Gibbs and Associates  
Moorpark CA USA  
Phone +1 805 523 0004  
sales@gibbscam.com

[www.productec.com](http://www.productec.com)  
[www.gibbscam.com](http://www.gibbscam.com)



« Tests have shown that a performance increase of up to 40% is possible with Blaser cutting oils. »

Daniel Schär  
Product Manager, Mechanical Engineer Dipl. Ing. FH

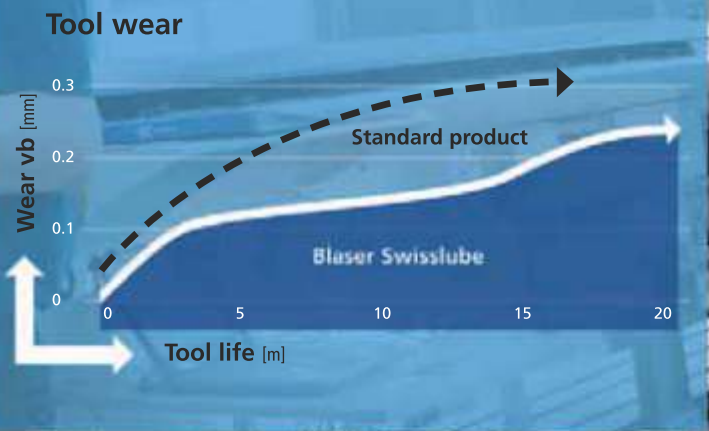

We are happy to serve you.



## UNCOMMON EXPERTISE

**At the recent Tornos watchmaking open days, visitors were able to discover the new fully automated machining solutions, for making a sliding pinion and a balance on the EvoDeco machines. Meanwhile, machines over 200 years old were at work in the company's showroom in a demonstration of hand guilloche work. An anachronism?**



When asked about the reason for this combination, Head of Marketing Brice Rengli explained: *“Tornos has specialised in the field of watchmaking since its establishment, and we have always sought to provide added value to our customers, and the presence of a guilloche worker at our exhibition is rooted in this same desire. We wanted to give visitors the opportunity to discover this activity, and/or do business with the guilloche worker.”*

### **There's always something to learn**

Bertrand Faivre, Head of the Applications Development Office at Tornos, told us: *“It's always interesting to discover how our ancestors resolved their technical problems, there's always something to learn from the solutions of the past, and good ideas to adopt.”* Tornos has no intention of replacing hand guilloche work – a must in high-end watches – by automated solutions, but this micro-technical operation par excellence deserves a closer look.

### **A few specialists across Europe**

The guilloche worker trade demands a combination of mechanical knowledge and a keen sense of art. The machines employed by the few guilloche workers still practising in Europe are all old machines built between 1750 and 1900, so mechanical knowledge is required to operate, maintain and repair them, or even prepare the tools. The artistic aspect is essential since the guilloche worker creates their pattern step by step and groove by groove, to achieve a surface appearance interacting with the light in the desired way.

### **Let's talk technology**

The principle of guilloche working is very straightforward - by moving a fixed tool in front of the part to be machined, each groove is applied in turn. Cam systems enable each groove to be made in wave form. There are two main types of machine, circular cam systems which can make “sunray” grooves, and

## The present

straight cam-type machines which can make parallel lined patterns. In both cases, the spacing between the lines is ensured by a mechanical system enabling fine and regular setting of the pitch between grooves. The combination of waves, angles and spacing has infinite variety, depending on the imagination and expertise of the guilloche worker.

the future of this trade: *“Even if machines can replace us, or partially so, the hand of the specialist remains highly sought-after by watchmaking brands, who do not wish to and cannot replace these high added-value manual operations in their high-end products.”*



### Extraordinary cycle times

Georges Brodbeck, an independent guilloche worker based in Saignel gier – in the heart of Watch Valley – told us: *“I work mainly for the watchmaking industry, making dials, oscillating weights, movement parts, main plates, bridges and cases. Depending on the complexity of the parts and the patterns to apply, it takes between 1 and 8 hours’ work!”* So it is no surprise that this work is still primarily carried out for high-end products.

### Little change over the past 200 years

While guilloche working operations can be replaced by NC programming on an automatic turning machine, the principles and motions remain the same, and the cycle times are also very long since the grooves are made in turn. There are other methods of creating such patterns, such as stamping, but the result is very different in terms of reflecting light. Mr. Brodbeck was confident when we asked about

To find out more about Tornos watchmaking solutions:

#### **Carlos Almeida**

Watchmaking Key Accounts  
Tel. +41 32 494 43 18  
almeida.c@tornos.com

And about guilloche working:

#### **Georges Brodbeck**

La Gru re 10  
2350 Saignel gier  
Tel. +41 32 951 25 04  
gbrodbeck@bluemail.ch

# “OVER THE TOP - MULTICUT ULTRA”

HIGH-PERFORMANCE CUTTING OILS BY  Zeller+Gmelin  
Mineralöle · Druckölöle · Chemie

**Zeller+Gmelin is a medium-sized mineral oil company with subsidiaries and trading partners across the world. As a specialist in innovative products and services, Zeller+Gmelin sees itself as a development partner and problem solver for its customers. This is evident in the fact that, for example, approximately 20% of the 460 employees at the main Eislingen plant are responsible for research and development. Zeller+Gmelin is certified to DIN EN ISO 9001:2008 (quality management) and DIN EN ISO 14001:2005 (environment management).**



Particularly in the field of metal machining, Zeller Gmelin offers an enormously wide range of high-performance lubricants products for the most varied of applications. For customers in the industrial sector, for example, there are over 700 different products – making Zeller-Gmelin a system supplier. Zeller+Gmelin has already been honoured four times with different accolades, such as the Innovation prize for medium-sized businesses in Germany (TOP 100) and the Supplier Award from the Bosch Group.

### Multicut ultra series

Multicut ultra are high-performance cutting oils which can be used to machine both high-alloy steel types such as chrome steel and titanium and non-ferrous metals and aluminium. Because of the



additives used, tool life can be increased substantially.

It is ideal thanks to its universal application, in both the watch and medical technology industries.

Why Multicut ultra stands out:

- viscosities 7, 10, 15 and 20
- low in aromatic compounds
- low levels of oil mist and vaporisation
- high flash point
- highest machining performance
- mild odour
- very mild on skin
- significant increase in tool life

### Sales and consultation

The two family-run sales partners, that have worked together for many years, are at your service as competent contacts. Excellent advice and a large range of services round off the comprehensive product range.



9450 Altstätten  
 Tel. +41 71 757 60 60  
 info@viscotex.ch  
 www.viscotex.ch

For French-speaking Switzerland:



2501 Biel/Bienne  
 Tel. +41 32 342 23 33  
 info@geigersa.ch  
 www.geigersa.ch

# PERFECT PROFILE.

zeus® Knurling Tools stand for process safety.



PRÄZISIONSWERKZEUGE

Whether standard or individual special solution: As global market leader in the field of Knurling Technology we offer you the highest quality and process safety for your workpieces.

Play it safe.  
Phone +49 74 24/97 05-0

Hommel+Keller  
Präzisionswerkzeuge GmbH  
D-78554 Aldingen  
[www.zeus-tooling.de](http://www.zeus-tooling.de)



The premium brand of Hommel+Keller



## MULTICUT ULTRA

Schneideöle ohne Kompromisse

Besuchen Sie uns an der SIAMS, Halle 1.1, Stand F-29 / F-24



**VISCOTEX**  
SCHMIERTECHNIK.

9450 Altstätten  
071 757 60 60  
[info@viscotex.ch](mailto:info@viscotex.ch)  
[www.viscotex.ch](http://www.viscotex.ch)

für die französische Schweiz



2501 Biel/Bienne  
032 342 23 33  
[info@geigersa.ch](mailto:info@geigersa.ch)  
[www.geigersa.ch](http://www.geigersa.ch)

## TORNOS COMMITMENT TO PROFESSIONAL TRAINING

**Awards and graduation ceremony for young skilled “cutting machine operators” from the technology training centre in Pirna-Copitz on 24th February 2012**



Thirty-eight young apprentices graduating in 2012 as “cutting machine operators” following training under the regulations of the Dresden Chamber of Commerce were presented with their leaving certificates at a ceremony on 24.02.2012.

In a short speech, Mr. Peter Feine, Head of Skilled Personnel at Interessenverband Metall- und Präzisionstechnik Osterzgebirge e.V. (IMPRO), headquartered in the Saxon watchmaking town of Glashütte, near Dresden, congratulated the graduates on behalf of the companies associated with IMPRO and awarded the best in class.

He wished them every success in their professional lives and underlined the fact that thanks to the modern, state-of-the-art technical equipment in the training facilities at the respective companies, graduates would have a sound basis for a successful transition into their chosen careers.

The awards ceremony was also the perfect opportunity to thank the expert trainers for their com-

mitment. For the trainers and head of department Manfred Renner, who is due to retire soon, it was particularly encouraging to hear that the graduates will be employed straight away, and be given the opportunity to apply their specialist knowledge and become recognised members of the workforce.

IMPRO also arranged a graduation ceremony worthy of all the graduates with a sparkling wine reception and extensive buffet. The event was attended by 30 young graduates and the trainers from BSZT Pirna. The evening ended on a high and is sure to be remembered fondly by all.

IMPRO works with partners such as the education authorities in the rural district of Sächsische Schweiz-Osterzgebirge and Tornos Technologies Deutschland GmbH to continue the tradition of specialist cutting machine training and to ensure optimum training conditions.

BSZT Pirna has an excellent array of basic technical training equipment, from conventional lathes to

## The present



CNC lathes and milling machines right up to the CNC machines used in the production units of the various companies, including Tornos.

In 2009, a CNC Tornos 10e automatic turning machine was purchased for training purposes at the request of Egon Herbrig, former Managing Director of Herbrig Präzisionsmechanik Bärenstein. Its inauguration was personally led by District Administrator Michael Geisler in the presence of representatives from Tornos and the IMPRO association.

Tornos has been a Friend of the training school since 2009 and will continue to provide expertise for specialist training in the future.



Promotion «Mécanicien d'usinage 2012»

### **Tornos Technologies Deutschland GmbH**

Frank Mortag  
Sales Director Thuringia/Saxony/Meckl.  
West. Pom.  
Karlsruher Str. 38  
75179 Pforzheim  
Germany  
Tel.: +49 (0) 7231 9107 0  
Fax: +49 (0) 7231 9107 50  
mortag.f@tornos.com  
www.tornos.com

### **IMPRO e. V. - Precision Mechanics Centre**

Peter Feine/Office Manager,  
Head of Skilled Personnel  
Hauptstr. 39, 01768 Glashütte/Sa.  
Germany  
Tel.: +49 (0) 35053 32091  
Fax: +49 (0) 35053 32097  
fachkraefte@impro-precision.de  
www.impro-precision.de  
www.impro-karriere.de  
www.facebook.com/Impro.Karriere

SOLUCIÓN INNOVATIVA PARA



**TORNOS** 

DELTA 12 / DELTA 20

configuración estándar

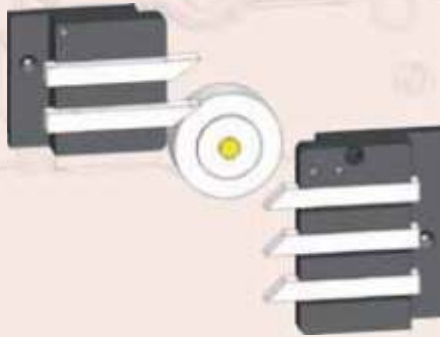

configuración Bimu

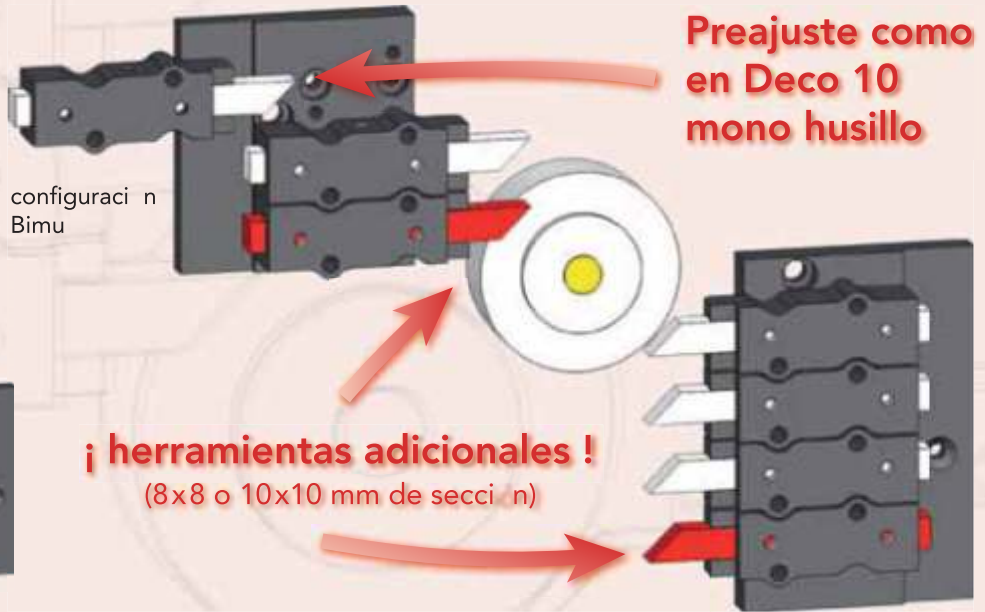

Preajuste como en Deco 10 mono husillo

**¡ herramientas adicionales !**  
(8x8 o 10x10 mm de sección)

SOLUCIÓN INNOVATIVA PARA



**TORNOS** 

GAMMA | DELTA | EVODECO 10

## Torneado en contra operación

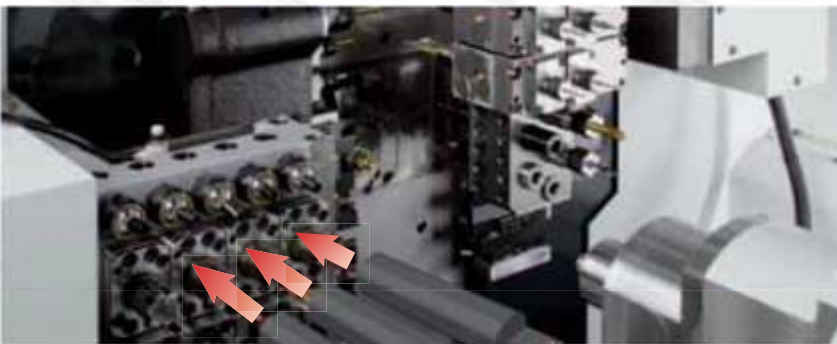

ISOline  
040line

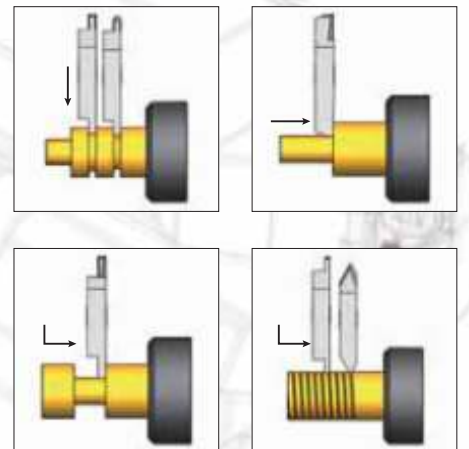

# APPLITEC SWISS TOOLING



SWISS MADE

## APPLITEC MOUTIER SA

Ch. Nicolas-Junker 2  
CH-2740 Moutier  
Switzerland

Tel. +41 32 494 60 20

Fax +41 32 493 42 60

[WWW.APPLITEC-TOOLS.COM](http://WWW.APPLITEC-TOOLS.COM)